



ACCESSOIRES ELNA

---

# CATALOGUE 2026





# BIENVENUE !

Depuis des décennies, la marque **elna** vous offre la qualité, l'innovation et un service après-vente réactif et efficace. Trois des nombreux aspects dont nous tenons à conserver la qualité aujourd'hui.

Pour la marque **elna**, les machines à coudre ne sont pas uniquement un outil technique mais surtout, des partenaires efficaces qui restent à vos côtés pendant un long moment, voire parfois, une vie entière. Même si vos connaissances en couture ne sont plus à prouver, nos machines à coudre vous donneront la possibilité de découvrir des nouveautés.

Notre mission est de vous permettre de développer vos propres talents au travers de ceux de votre machine à coudre **elna**. Pour ce faire, il vous faut utiliser les bons outils, compatibles avec votre modèle **elna**, et destinés à réaliser la tâche que vous désirez effectuer.

Dans ce catalogue, vous retrouverez ou découvrirez les accessoires optionnels **elna** qui vous aideront à concrétiser vos idées tout en simplifiant les difficultés techniques!

Prenez également le temps de visiter notre site internet [www.elna.com](http://www.elna.com) dans lequel vous trouverez notamment les instructions sur l'utilisation de nos accessoires standards et optionnels. Enfin, n'oubliez pas que plus vous consacrerez de temps à vous entraîner, plus vos résultats seront réussis et parfaitement exécutés.

Merci d'avoir choisi **elna**!

## Table des matières

Couture, Patchwork et Quilting   5-7mm	pages 4 à 26
Couture, Patchwork et Quilting   9mm	pages 27 à 41
Broderie	pages 42 à 51
Surjeteuses et recouvreuses	pages 52 à 64
Général	pages 65 à 81
Aiguilles standard et optionnels	pages 82 à 85





## ACCESSOIRES DE COUTURE, DE PATCHWORK ET DE QUILTING

Pour les machines à coudre avec une largeur  
de couture de 5 à 7 millimètres

Si vous êtes un amoureux de la couture et un passionné de DIY vous allez adorer découvrir notre vaste collection d'accessoires elna. Vous apprendrez petit à petit comment simplifier des tâches laborieuses et pourrez améliorer vos connaissances, ainsi que vos capacités techniques grâce à nos accessoires. Ces derniers vous aideront certainement à expérimenter de nouvelles techniques, mais dans tous les cas, à finaliser vos projets!



Les modèles de machines à coudre concernés par cette catégorie sont:

Sew Fun, Sew Green, Sew Zebra et Sew 75 (elna 1000)  
eXplore 150 et 160  
eXplore 220, 220S, 240, 240S (elna 2100, 2110, 2130, 2300)  
eXplore 320, 320S, 340, 340S (elna 2600, 2800)  
3210 *designed for jeans* (elna 3210, 3230)  
elna Star et elna Star Edition  
eXperience 450  
eXperience 520, 540, 520S, 540S (elna 5100, 5200, 5300)  
eXperience 530, 550, 560, 570, 570α  
eXcellence 580 et 580+ *incluant Fashion & Decor Edition*  
elna lotus et lotus 2  
eXcellence 720 (elna 7200)

N.B. : les anciens modèles correspondants aux modèles de la gamme actuelle sont indiqués entre parenthèses.

Appareil à plisser



Ref.:943-100-020



150, 160, 220/S, 240/S, 320/S, 340/S, 3210j, Star, Lotus/2, 450, 520/S, 530, 540/S, 550, 560, 570/α, 580/+

Appareil à plisser avec fixation à la barre aiguille

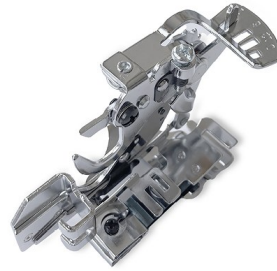

Ref.:941-620-305



Sew, 220/S, 240/S

Appareil à plisser avec fixation à la barre aiguille

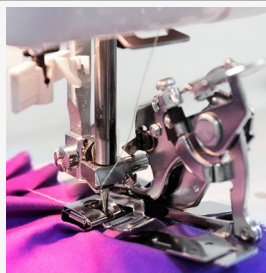

Ref.:941-623-000A



150, 160, 220/S, 240/S, 320/S, 340/S, 3210j, Lotus/2, 450, 520/S, 540/S, 530, 550, 560, 570/α

Appareil à plisser avec pied encliquetable

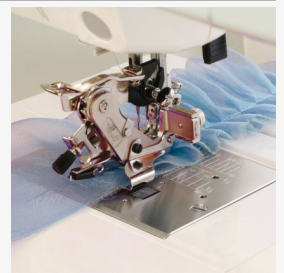

Ref.:846-415-031



150, 160, 320/S, 340/S, 3210j, Star, Lotus/2, 450, 520/S, 530, 540/S, 550, 560, 570/α, 580/+ , 720

Kit de pieds pour ourlet roulé (D) : set de 2 pieds (4mm et 6mm)

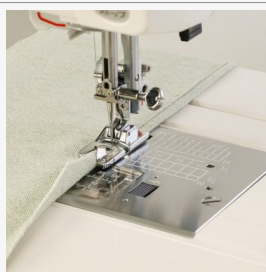

Ref.:200-326-023



150, 160, 320/S, 340/S, 3210j, Star, Lotus/2, 450, 520/S, 530, 540/S, 550, 560, 570/α, 580/+ , 720

Pied ¼" pour règles à quilting pour modèles 7 mm à tige basse



Ref.:202-492-005



elna Star, 450, 520/s, 540/s, Lotus 1, 530, 550, 560, 570/α, 660, 620, 720

Pied à border et à repriser à fourche ouverte P-2

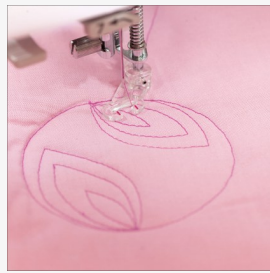

Ref.:200-337-027



580/+, 720

Pied à broder et à repriser à fourche ouverte



Ref.:200-340-023



150, 160, 320/S, 340/S, 3210j, Star, Lotus/2, 450, 520/S, 540/S, 530, 550, 560, 570/α

Pied à double niveau gauche



Ref.:202-539-005



520/S, 530, 540/S, 550, 560, 570/α, 580/+

Pied à froncer (V)

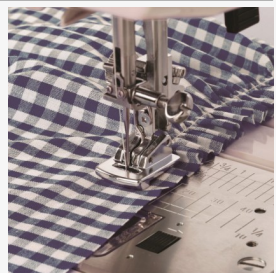
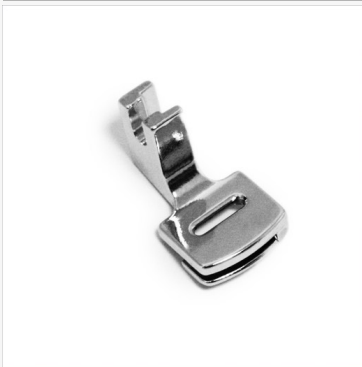

Ref.:200-124-029



Sew, 220/S, 240/S

Pied à froncer (V)

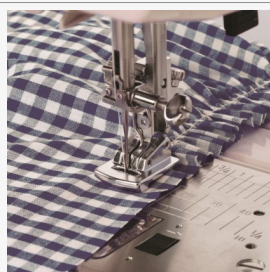

Ref.:200-315-029



150, 160, 320/S, 340/S, 3210j, Star, Lotus/2, 450, 520/S, 530, 540/S, 550, 560, 570/α, 580/+, 720

Pied à rouleau HD



Ref.:202-420-002



580/+

Pied à rouleau pour cuir et daim



Ref.:200-142-023



Sew, 220/S, 240/S

Pied à rouleau pour cuir et daim



Ref.:200-316-020



150, 160, 320/S, 340/S, 3210j, Star, Lotus/2, 450, 520/S, 530, 540/S, 550, 560, 570/α, 580/+, 720

Pied avec guide central



Ref.:200-341-024



150, 160, 320/S, 340/S, 3210j, Star, Lotus/2, 450, 520/S, 530, 540/S, 550, 560, 570/α, 580/+, 720

Pied avec guide de couture ajustable intégré



Ref.:202-221-001



320/S, 340/S, 3210j, Star, Lotus/2, 450, 520/S, 530, 540/S, 550, 560, 570/α, 580/+, 720

Pied boutonnière automatique (R)



Ref.:753-801-004



340/S, 3210Jeans, Star, Lotus/2, 520/S, 540/S, 520, 540, 620, 660, 720, 740, 580/+,

Pied en métal (A)



Ref.:611-511-001



Sew, 220/S, 240/S

### Pied en métal avec fente à gauche (A)

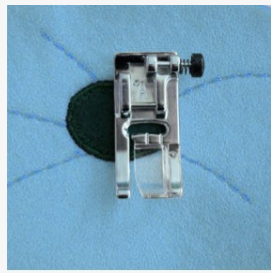

Ref.:825-510-032



3210j, Star, Lotus/2, 520/S, 540/S, 530, 550, 560, 570/α, 580/+, 720

### Pied étroit pour pose de fermeture éclair



Ref.:200-334-024



580/+, 740

### Pied étroit pour pose de fermeture éclair



Ref.:200-342-025



Sew, 150, 160, 220/S, 240/S, 320/S, 340/S, 3210j, Star, Lotus/2, 450, 520/S, 540/S, 530, 550, 560, 570/α

### Pied guide pour couture en bordure (SE)



Ref.:202-252-001



150, 160, 320/S, 340/S, 3210j, Star, Lotus/2, 450, 520/S, 530, 540/S, 550, 560, 570/α, 580/+, 720

### Pied jersey



Ref.:202-509-026



Sew, 220/S, 240/S

### Pied overlock (M)

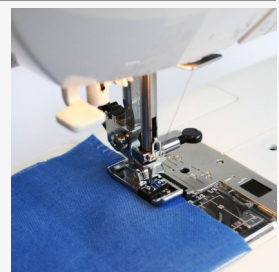

Ref.:822-808-008



320/S, 340/S, 3210j, Star, Lotus/2, 520/S, 530, 550, 560, 570/α, 580/+, 720

Pied patchwork pour couture  
¼ de pouce (O)



Ref.:200-318-022



150, 160, 320/S, 340/S, 3210j, Star, Lotus/2, 450, 520/S, 530, 540/S, 550, 560, 570/α, 580/+, 720,

Pied patchwork pour couture  
¼ de pouce (O)

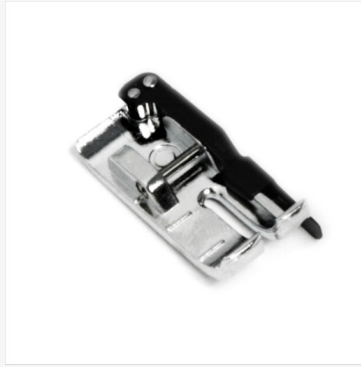

Ref.:200-330-020



Sew, 220/S, 240/S

Pied patchwork pour couture  
¼ de pouce sans guide (O)



Ref.:202-527-000



150, 160, 320/S, 340/S, 3210j, Star, Lotus/2, 450, 520/S, 530, 540/S, 550, 560, 570/α, 580/+, 720,

Pied pour application (F)

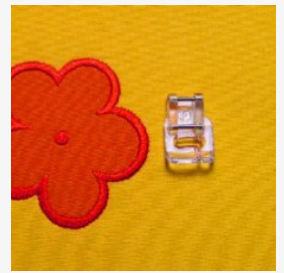

Ref.:202-023-012



150, 160, 320/S, 340/S, 3210j, Star, Lotus/2, 450, 520/S, 530, 540/S, 550, 560, 570/α, 580/+, 720

Pied pour boucles ou franges

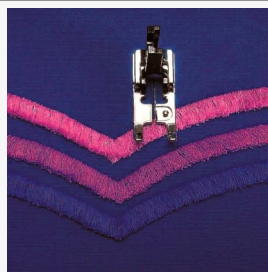

Ref.:200-050-104



580/+, 720

Pied pour boucles ou franges

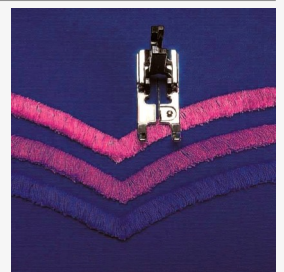

Ref.:200-051-105



320/S, 340/S, 3210j, Star, Lotus/2, 450, 520/S, 540/S, 530, 550, 560, 570/α

Pied pour boucles ou franges



Ref.:200-101-008

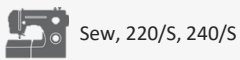

Pied pour boutonnière en 4 étapes



Ref.:200-123-028



Pied pour boutonnière en 4 étapes ajustable (J)

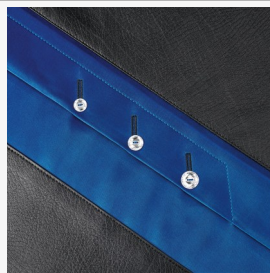

Ref.:200-134-022



Pied pour boutonnière extra-longue ou difficile d'accès



Ref.:820-801-016

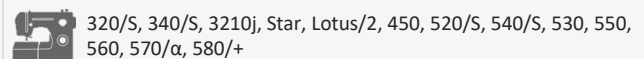

Pied pour couture droite

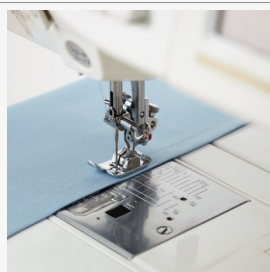
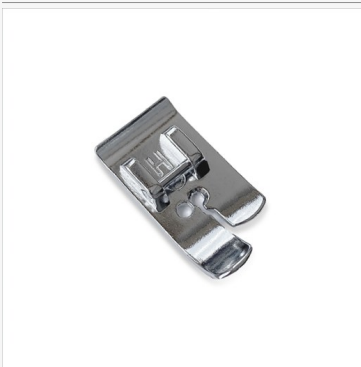

Ref.:200-331-021

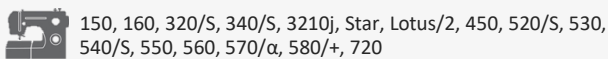

Pied pour couture droite pour position d'aiguille au centre

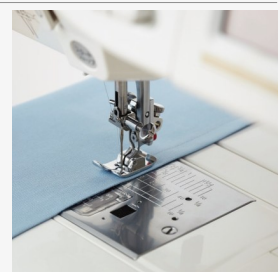

Ref.:200-125-020

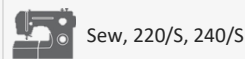

Pied pour coutures rabattues (LS)



Ref.: 202-511-001



150, 160, 320/S, 340/S, 3210j, Star, Lotus/2, 450, 520/S, 530, 540/S, 550, 560, 570/α, 580/+, 720,

Pied pour double transport à fourche ouverte



Ref.:941-610-000



Sew, 220/S, 240/S

Pied pour fleurs (Flower stitcher)



Ref.:202-258-007



150, 160, 220/S, 240/S, 320/S, 340/S, 3210j, Star, Lotus/2, 450, 520/S, 540/S, 530, 550, 560, 570/α

Pied pour guide pour biais (TG)

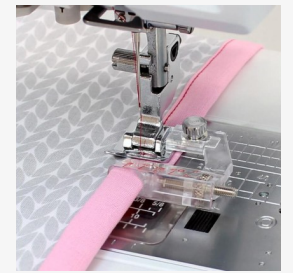
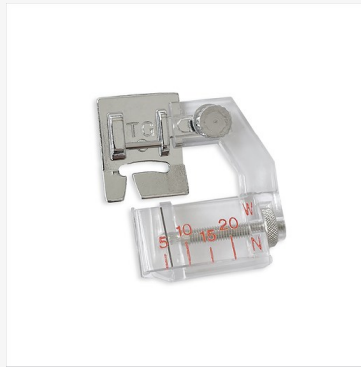

Ref.:202-392-004



150, 160, 320/S, 340/S, 3210j, Lotus/2, 450, 520/S, 540/S, 530, 550, 560, 570/α, 580+

Pied pour nervures étroites avec aiguille jumelée



Ref.:200-328-025



Sew, 220/S, 240/S

Pied pour ourlet invisible ajustable (G)



Ref.:820-817-015



150, 160, 220/S, 240/S, 320/S, 340/S, 3210j, Star, 450, 520/S, 540/S, 530, 550, 560, 570/α, 580/+, 720

### Pied pour ourlet invisible ajustable (L)



Ref.:200-130-028

Sew, 220/S, 240/S

### Pied pour ourlet invisible avec guide médian fixe (G)



Ref.:395-719-48

150, 160, 220/S, 240/S, 320/S, 340/S, 3210j, Star, Lotus/2, 450, 520/S, 540/S, 530, 550, 560, 570/α, 580/+, 720

### Pied pour ourlet roulé (D)



Ref.:202-251-000

Sew, 220/S, 240/S

### Pied pour ourlet roulé 3mm (D)



Ref.:820-809-014

150, 160, 3210j, Lotus/2, 450, 520/S, 540/S, 530, 550, 560, 570/α, 580+

### Pied pour passepoil

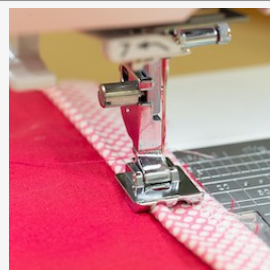

Ref.:200-314-028

150, 160, 320/S, 340/S, 3210j, Star, Lotus/2, 450, 520/S, 530, 540/S, 550, 560, 570/α, 580/+, 720

### Pied pour pose de biais - pied à border

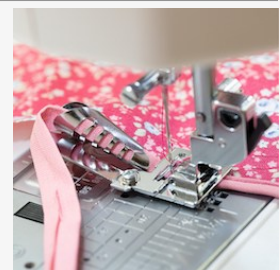

Ref.:200-140-021

Sew, 220/S, 240/S

Pied pour pose de biais - pied à border

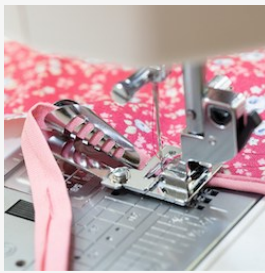

Ref.:200-313-027



150, 160, 320/S, 340/S, 3210j, Star, Lotus/2, 450, 520/S, 530, 540/S, 550, 560, 570/a, 580/+, 720

Pied pour pose de bouton (T)



Ref.:200-131-029



Sew, 220/S, 240/S

Pied pour pose de bouton (T)



Ref.:200-136-024



320/S, 340/S, 3210j, Star, Lotus/2, 450, 520/S, 540/S, 530, 550, 560, 570/α, 580/+, 720

Pied pour pose de cordonnets (H)

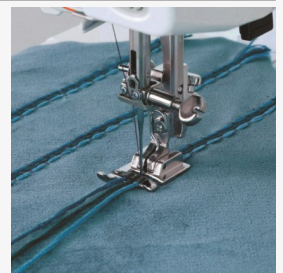
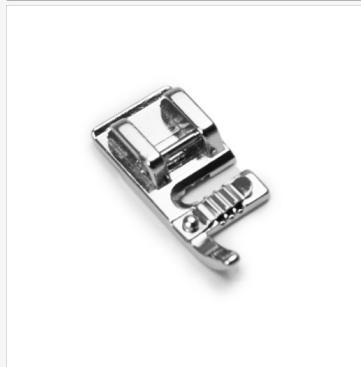

Ref.:200-126-021



Sew, 220/S, 240/S

Pied pour pose de cordonnets (H)

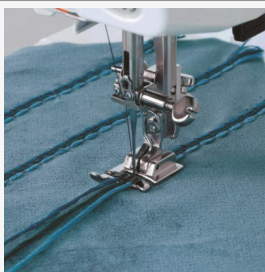

Ref.:200-345-028



150, 160, 320/S, 340/S, 3210j, Star, Lotus/2, 450, 520/S, 530, 540/S, 550, 560, 570/α, 580/+, 720

Pied pour pose de fermeture éclair

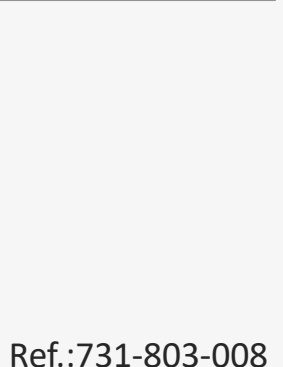
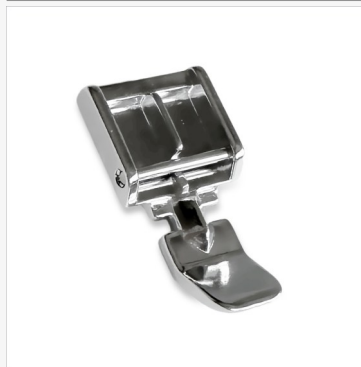

Ref.:731-803-008



Sew, 220/S, 240/S

Pied pour pose de fermeture éclair (E)



Ref.:808-852-003



320/S, 340/S, 3210Jeans, Star, Lotus/2, 450, 520/S, 540/S, 530, 550, 560, 570, 570/α, 620, 660, 720, 740, 580/+

Pied pour pose de fermeture éclair invisible (Z)



Ref.:202-499-002



Sew, 220/S, 240/S

Pied pour pose de fermeture éclair invisible (Z)

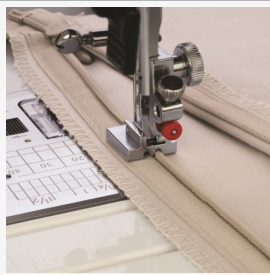

Ref.:200-333-023



150, 160, 320/S, 340/S, 3210j, Star, Lotus/2, 450, 520/S, 530, 540/S, 550, 560, 570/α, 580/+, 720, 808

Pied pour pose de paillettes et de rubans



Ref.:200-332-022



150, 160, 320/S, 340/S, 3210j, Star, Lotus/2, 450, 520/S, 530, 540/S, 550, 560, 570/α, 580/+, 720

Pied pour pose de perles et de mèches de 2 et 4 mm

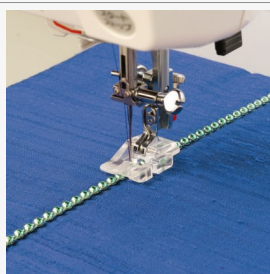

Ref.:200-321-028



150, 160, 320/S, 340/S, 3210j, Star, Lotus/2, 450, 520/S, 530, 540/S, 550, 560, 570/α, 580/+, 720

Pied pour quilting en piqué libre pour modèles à tige haute

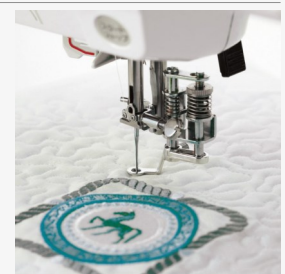
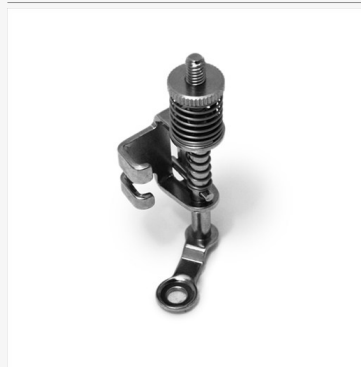

Ref.:200-442-015



580/+, 720

Pied pour surfilage (C)

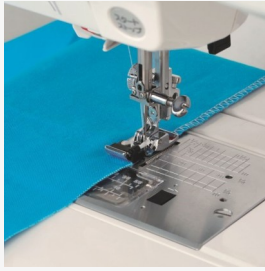

Ref.:822-801-001



320/S, 340/S, 3210j, Star, Lotus/2, 450, 540/S, 530, 550, 560, 570/α, 580/+, 720

Pied pour surfilage (G)

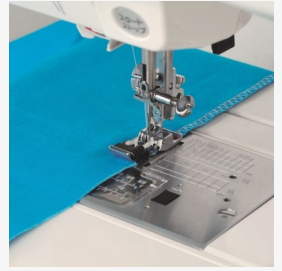

Ref.:200-132-020



Sew, 220/S, 240/S

Pied quilting en piqué libre



Ref.:200-127-022



Sew, 220/S, 240/S

Pied quilting en piqué libre



Ref.:200-325-022



580/+, 720

Pied quilting en piqué libre



Ref.:200-349-022



150, 160, 320/S, 340/S, 3210j, Star, Lotus/2, 450, 520/S, 540/S, 530, 550, 560, 570/α

Pied quilting pour broderie à fil couché (FMC)



Ref.:202-142-007



580/+

### Pied satin (F)



Ref.:822-804-118



320/S, 340/S, 3210Jeans, Star, Lotus/2, 450, 520/S, 540/S, 530, 550, 560, 570/α, 620, 660, 720, 740, 580/+

### Pied satin à fourche ouverte



Ref.:200-137-025



150, 160, 320/S, 340/S, 3210j, Star, Lotus/2, 450, 520/S, 530, 540/S, 550, 560, 570/α, 580/+, 720

### Pied satin avec guides intégrés (FB)

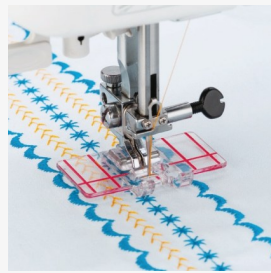
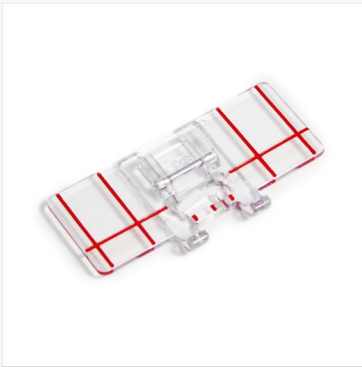

Ref.:200-434-025



150, 160, 320/S, 340/S, 3210j, Star, Lotus/2, 450, 520/S, 530, 540/S, 550, 560, 570/α, 580/+, 720

### Pied satin multifonctions (F)



Ref.:200-129-024



Sew, 220/S, 240/S

### Pied soutache



Ref.:494-660-15



Sew, 220/S, 240/S

### Pied transport supérieur ¼ de pouce – système I.A.F

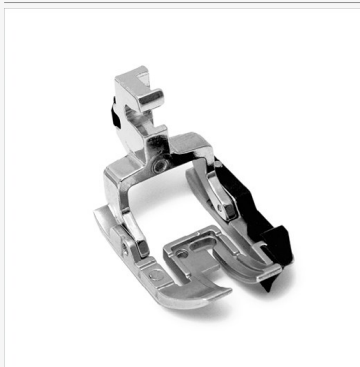

Ref.:846-423-009



580+, 720

Pied transport supérieur ¼ de pouce et plaque aiguille – système I.A.F



Ref.:846-407-041



Pied transport supérieur à fourche ouverte - système I.A.F

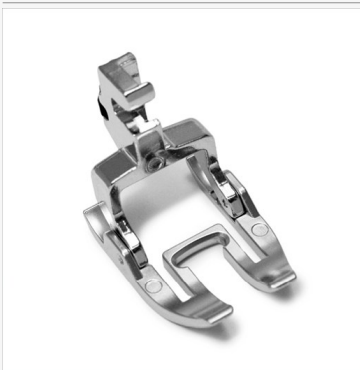

Ref.:846-410-047



Pied transport supérieur avec guide central – système I.A.F



Ref.:846-413-062



Pied ultra-glisse antiadhérent



Ref.:200-141-022

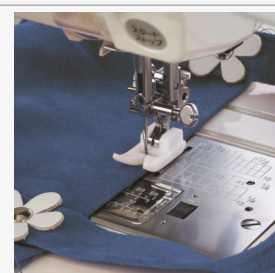
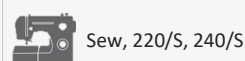

Pied ultra-glisse antiadhérent



Ref.:200-329-026

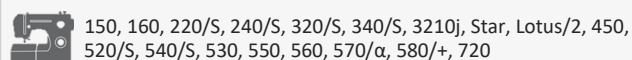

Pied zigzag transparent avec protection doigts



Ref.:749-522-005

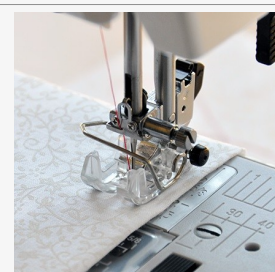
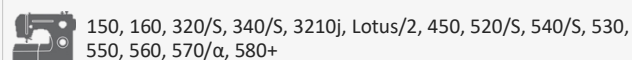

Unité pour double transport avec guide de matelassage

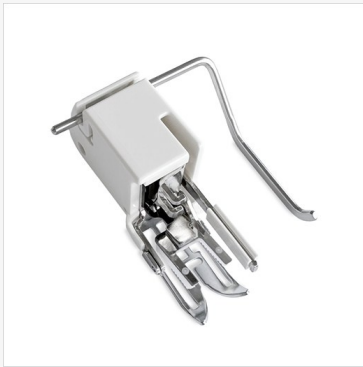

Ref.:200-309-019

Unité pour double transport avec guide de matelassage



Ref.:200-310-013

580/+

Sew, 220/S, 240/S

Unité pour double transport avec guide de matelassage



Ref.:200-311-014

Unité pour double transport avec pied à fourche ouverte et guide de matelassage

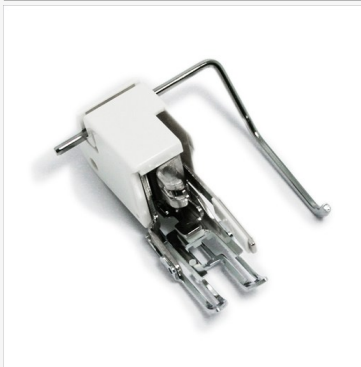

Ref.:200-338-028

150, 160, 320/S, 340/S, 3210j, Star, Lotus/2, 450, 520/S, 540/S, 530, 550, 560, 570/α

580/+, 808

Unité pour double transport avec pied à fourche ouverte et guide de matelassage



Ref.:200-339-029

Kit complet avec unité pour double transport



Ref.:214-516-014

150, 160, 320/S, 340/S, 3210j, Star, Lotus/2, 450, 520/S, 540/S, 530, 550, 560, 570/α

580/+

Kit complet avec unité pour double transport



Ref.:214-517-015



150, 160, 320/S, 340/S, 3210j, Star, Lotus/2, 450, 520/S, 540/S, 530, 550, 560, 570/α

Kit complet de pieds pour le quilting en piqué libre



Ref.:202-001-014



580/+, 720

Kit complet de pieds pour le quilting en piqué libre



Ref.:202-002-015



150, 160, 320/S, 340/S, 3210j, Star, Lotus/2, 450, 520/S, 540/S, 530, 550, 560, 570/α

Kit de pieds pour le quilting en piqué libre



Ref.:767-434-016



150, 160, 320/S, 340/S, 3210j, Star, Lotus/2, 520/S, 540/S, 450, 530, 550, 560, 570/α, 580/+, 720, 808 - Only as an addition to 202-002-015 / 202-001-014

Pied transparent de quilting avec guides

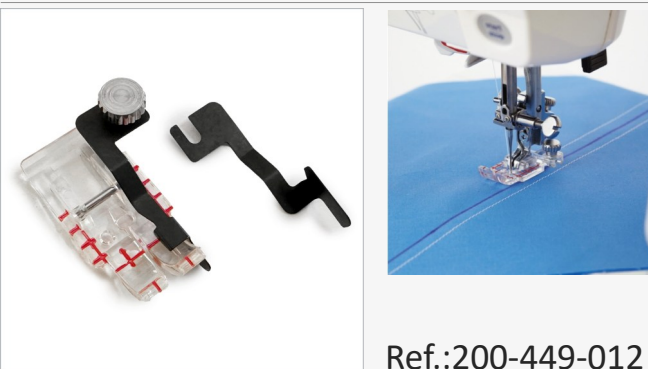

Ref.:200-449-012



150, 160, 320/S, 340/S, 3210j, Star, Lotus/2, 450, 520/S, 530, 540/S, 550, 560, 570/α, 580/+, 720

Pieds pour nervures avec aiguille jumelée - large et étroit

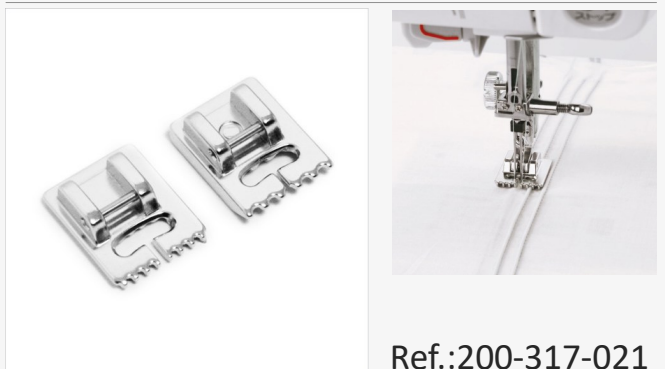

Ref.:200-317-021



150, 160, 320/S, 340/S, 3210j, Star, Lotus/2, 520/S, 530, 540/S, 550, 560, 570/α, 580/+, 720

### Dispositif et pied pour pose de biais

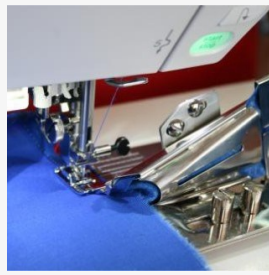

Ref.:202-250-009



Lotus/2, 580/+, 720

### Guide de couture sur rubans - large

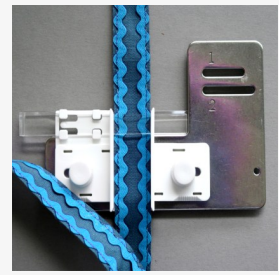

Ref.:200-444-419



150, 160, 320/S, 340/S, Star, Lotus/2, 450, 520/S, 540/S, 530, 550, 560, 570/α, 580/+

### Guide de matelassage



Ref.:802-422-002



150, 160, 320/S, 340/S, 3210j, Star, Lotus/2, 450, 520/S, 530, 540/S, 550, 560, 570/α, 580/+

### Guide étroit pour nervures renforcées par la pose de cordonnets (A)



Ref.:503-810-005



150, 160, 3210j, 450, Lotus/2

### Guide large pour nervures renforcées par la pose de cordonnets (B)



Ref.:503-809-001



150, 160, 3210j, 450, Lotus/2

### Guide-tissu T



Ref.:200-100-100



150, 160, 220/S, 240/S, 320/S, 340/S, 3210j, 450, 520/S, 540/S, 530, 550, 560, 570/α, Lotus/2, 580/+

Plaque stabilisatrice pour pied boutonnière automatique (R)



Ref.:202-030-001



240/S, 340/S, 3210j, Star, Lotus/2, 520/S, 540/S, 530, 550, 560, 570/α, 580/+, 720  
For 7mm models use plate holder 200-428-406

Guide de matelassage et guide pour couture centrale



Ref.:202-249-005



150, 160, 220/S, 240/S, 320/S, 340/S, 3210j, Star, Lotus/2, 450, 520/S, 530, 540/S, 550, 560, 570/α, 580/+

Guides pour nervures renforcées par la pose de cordonnets - large et étroit



Ref.:200-324-021



320/S, 340/S, Star, 520/S, 540/S

Guides pour nervures renforcées par la pose de cordonnets - large et étroit



Ref.:202-238-001



530, 550, 560, 570/α, 580/+

Guides pour nervures renforcées par la pose de cordonnets - large et étroit



Ref.:503-813-028



3210j, 530, 550, 560, 570/α

Longs guides de matelassage



Ref.:202-025-405



150, 160, 320/S, 340/S, 3210j, Star, Lotus/2, 450, 520/S, 530, 540/S, 550, 560, 570/α, 580/+

Plaque aiguille pour couture droite



Ref.:200-088-101



520/S, 540/S

Plaque aiguille pour couture droite



Ref.:503-821-009



3210j

Plaque aiguille pour couture droite

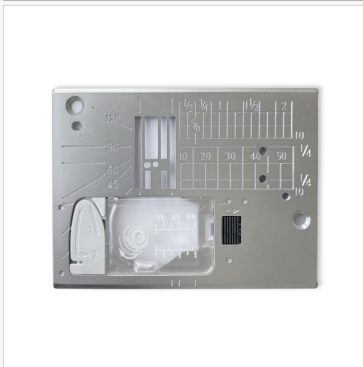

Ref.:809-833-012

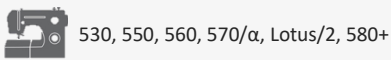

530, 550, 560, 570/α, Lotus/2, 580+

Plaque aiguille pour couture droite

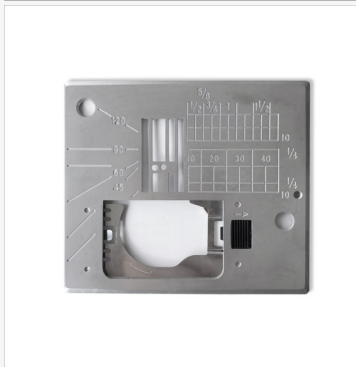

Ref.:846-833-109



720

Capsule spéciale basse-tension pour quilting en piqué libre



Ref.:200-445-029

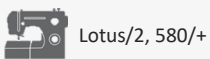

Lotus/2, 580/+

Capsule spéciale basse-tension pour quilting en piqué libre



Ref.:202-006-019

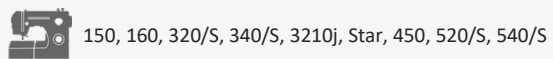

150, 160, 320/S, 340/S, 3210j, Star, 450, 520/S, 540/S

Couture, Patchwork et Quilting 5-7mm

Capsule spéciale pour gros fil ou fil à broder



Ref.:200-056-007



320/S, 340/S, 3210j, Star, 450, 520/S, 540/S

Guide pour couture circulaire



Ref.:202-106-029



3210j, 720

Guide pour couture circulaire



Ref.:202-107-020



320/S, 340/S, Star, 520/S, 540/S

Guide pour couture circulaire



Ref.:202-242-008



530, 550, 560, 570/α, 580/+

Guide fronçeur pour élastique - 10 mm de largeur

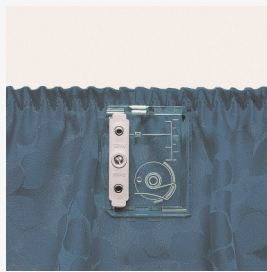

Ref.:495-845-20



320/S, 340/S, Star, 520/S, 540/S

Guide fronçeur pour élastique - 10 mm de largeur



Ref.:495-846-20



150, 160, 3210j, 450, Lotus/2, 720

Guide fronceur pour élastique - 13 mm de largeur

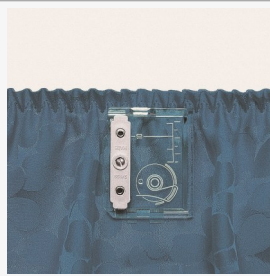

Ref.:495-525-20

320/S, 340/S, Star, 520/S, 540/S

Guide fronceur pour élastique - 13 mm de largeur

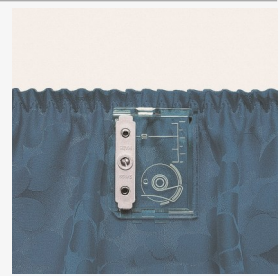

Ref.:495-526-20

150, 160, 3210j, 450, Lotus/2, 720

Guide fronceur pour élastique - 8 mm de largeur

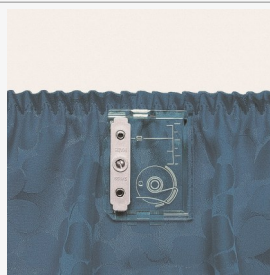

Ref.:495-390-20

320/S, 340/S, Star, 520/S, 540/S

Guide fronceur pour élastique - 8 mm de largeur

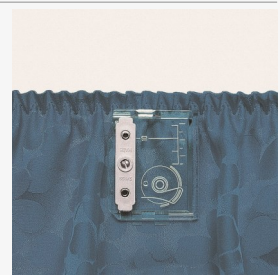

Ref.:495-395-20

150, 160, 3210j, 450, Lotus/2, 720

Plaquette faux-jour étroite pour espace de 2.5 mm



Ref.:395-731-58

3210j, 450, Lotus/2, 720

Plaquette faux-jour étroite pour espace de 2.5 mm



Ref.:495-560-20

320/S, 340/S, Star, 520/S, 540/S

Plaquette faux-jour étroite pour espace de 5 mm



Ref.:395-731-59



3210j, Lotus/2, 720

Loupe optique amovible (1.2x)



Ref.:202-399-001



530, 550, 560, 570/α, 580/+

Kit loupes optiques amovibles.

Set de trois loupes optiques 1.2x, 1.4x et 1.6x.



Ref.:202-157-005



530, 550, 560, 570/α, 580/+



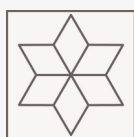

## ACCESSOIRES DE COUTURE, DE PATCHWORK ET DE QUILTING

Pour les machines à coudre avec une largeur  
de couture de 9 millimètres

Voici la collection d'accessoires dédiés à la couture qui ont été conçus spécialement pour nos modèles de machines à coudre informatisées haut de gamme. Ces modèles puissants offrent de multiples fonctions supérieures, un espace de travail extra-large pour un confort de couture ultime. Grâce aux accessoires compatibles avec votre modèle, vous pourrez non seulement décupler vos possibilités mais aussi gagner du temps en simplifiant des procédés techniques ardues.



Les modèles de machines à coudre concernés par cette catégorie sont:

eXcellence 680 et 680+ *incluant Fashion & Decor Edition*  
eXcellence 710  
eXcellence 720PRO  
eXcellence 730 et 730PRO  
eXcellence 760 et 760PRO  
eXcellence 770 et 772  
eXcellence 780 et 780+  
eXcellence 782  
eXcellence 790PRO/dressmaker et 792PRO

### Appareil à plisser

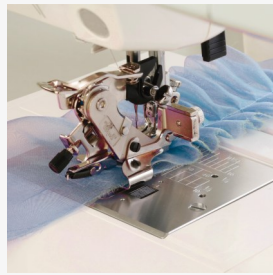

Ref.:202-095-200



680/+, 710, 720PRO, 730/PRO, 760/PRO, 770, 772, 780/+, 782, 790PRO/dressmaker, 792PRO, 850, 860, 900, 920

### Pied à 9 trous pour pose de cordonnets H2



Ref.:202-507-004



772, 782, 792PRO

### Pied à broder et à repriser à fourche ouverte PD-H

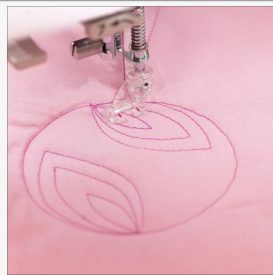

Ref.:202-314-022



680/+, 710, 720PRO, 730/PRO, 760/PRO, 770, 772, 780/+, 782, 790PRO, 792PRO, 850, 860, 900, 920

### Pied à double entraînement Dual Feed ¼ de pouce - système large (OD)



Ref.:202-235-008



710, 720PRO, 730/PRO, 760/PRO, 770, 772, 780/+, 782, 790PRO/dressmaker, 792PRO, 900, 920

### Pied à double entraînement Dual Feed à fourche ouverte - système large (UD)

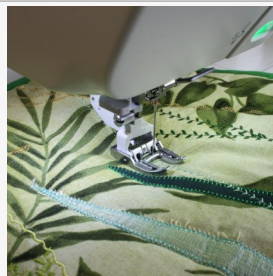

Ref.:202-236-009



710, 720PRO, 730/PRO, 760/PRO, 770, 772, 780/+, 782, 790PRO/dressmaker, 792PRO, 900, 920

### Pied à double entraînement Dual Feed avec guide central - système large (SD)

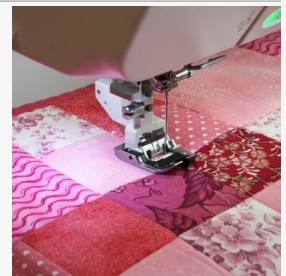

Ref.:202-103-202



710, 720PRO, 730/PRO, 760/PRO, 770, 772, 780/+, 782, 790PRO/dressmaker, 792PRO, 900, 920

Pied à froncer (V)



Ref.:202-096-201



680/+, 710, 720PRO, 730/PRO, 760/PRO, 770, 772, 780/+, 782, 790PRO/dressmaker, 792PRO, 850, 860, 900, 920

Pied à rouleau HD

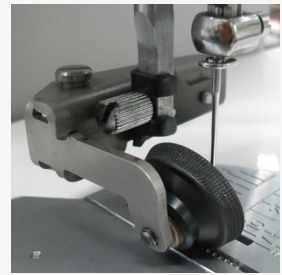

Ref.:202-420-002



680/+, 720PRO, 730/PRO, 760/PRO, 770, 772, 780/+, 782, 790PRO/dressmaker, 792PRO, 850, 860, 920

Pied avec guide central (S)



Ref.:202-087-209



680/+, 710, 720PRO, 730/PRO, 760/PRO, 770, 772, 780/+, 782, 790PRO/dressmaker, 792PRO, 850, 860, 900, 920

Pied avec guide de couture ajustable intégré



Ref.:202-294-005



680/+, 710, 720PRO, 730/PRO, 760/PRO, 770, 772, 780/+, 782, 790PRO/dressmaker, 792PRO, 850, 860, 920

Pied étroit pour pose de fermeture éclair



Ref.:200-334-024



680/+, 720PRO, 730/PRO, 760/PRO, 770, 772, 780/+, 782, 850, 860, 900, 920

Pied guide pour couture en bordure (SE)



Ref.:202-100-209



680/+, 710, 720PRO, 730/PRO, 760/PRO, 770, 772, 780/+, 782, 790PRO, 792PRO, 850, 860, 900, 920

Pied patchwork pour couture ¼ de pouce (O)

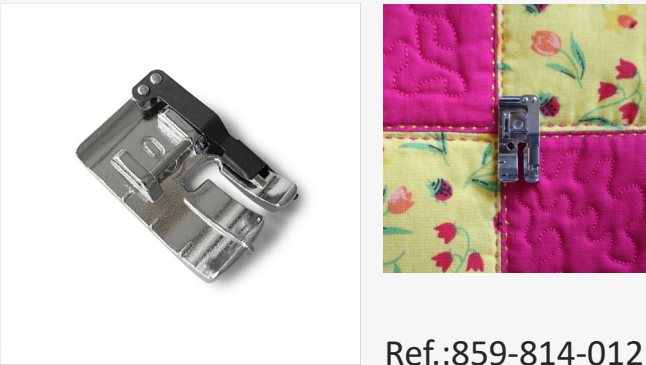

680/+, 720PRO, 730/PRO, 760/PRO, 770, 780/+, 850, 860, 920

Pied patchwork pour couture ¼ de pouce sans guide (O)



680/+, 710, 720PRO, 730/PRO, 760/PRO, 770, 772, 780/+, 782, 790PRO, 792PRO, 850, 860, 900, 920

Pied pour application (AP)



680/+, 710, 720PRO, 730/PRO, 760/PRO, 770, 772, 780/+, 782, 790PRO/dressmaker, 792PRO, 850, 860, 900, 920

Pied pour boutonnière extra-large avec plaque stabilisatrice



680/+, 710, 720PRO, 730/PRO, 760/PRO, 770, 772, 780/+, 790PRO, 792PRO, 850, 860, 920

Pied pour boutonnière extra-longue ou difficile d'accès (B)



680/+, 710, 720PRO, 730/PRO, 760/PRO, 770, 772, 780/+, 782, 790PRO/dressmaker, 792PRO, 850, 860, 900, 920

Pied pour couture droite (ST)



680/+, 710, 720PRO, 730/PRO, 760/PRO, 770, 772, 780/+, 782, 790PRO/dressmaker, 792PRO, 850, 860, 900, 920

### Pied pour coutures rabattues (LS)



Ref.:202-490-003



680/+, 710, 720PRO, 730/PRO, 760/PRO, 770, 772, 780/+, 782, 790PRO, 792PRO, 850, 860, 900, 920

### Pied pour guide pour biais (TG)

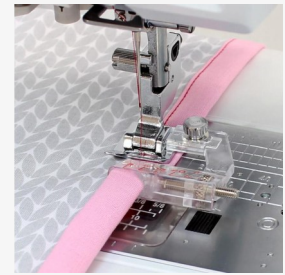
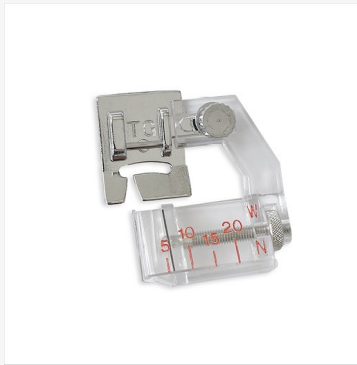

Ref.:202-391-003



680/+, 720PRO, 730/PRO, 760/PRO, 770, 772, 780/+, 782, 792PRO, 850, 860, 900, 920

### Pied pour nervures étroites avec aiguille jumelée (N2)



Ref.:202-094-209



680/+, 710, 720PRO, 730/PRO, 760/PRO, 770, 772, 780/+, 782, 790PRO/dressmaker, 792PRO, 850, 860, 900, 920

### Pied pour nervures larges avec aiguille jumelée (N1)

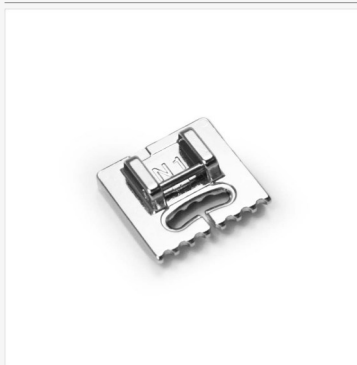

Ref.:202-093-208



680/+, 710, 720PRO, 730/PRO, 760/PRO, 770, 772, 780/+, 782, 790PRO/dressmaker 792PRO, 850, 860, 900, 920

### Pied pour ourlet roulé 4 mm de largeur (D2)



Ref.:202-081-203



680/+, 710, 720PRO, 730/PRO, 760/PRO, 770, 772, 780/+, 782, 790PRO/dressmaker, 792PRO, 850, 860, 900, 920

### Pied pour ourlet roulé 6 mm de largeur (D1)



Ref.:202-080-202



680/+, 710, 720PRO, 730/PRO, 760/PRO, 770, 772, 780/+, 782, 790PRO/dressmaker, 792PRO, 850, 860, 900, 920

Pied pour passepoil (étroit) - Largeur max. de la mèche 3 mm



Ref.:202-489-009



680/+, 710, 720PRO, 730/PRO, 760/PRO, 770, 772, 780/+, 782, 790PRO/dressmaker, 792PRO, 850, 860, 900, 920

Pied pour passepoil (l) - Largeur max. de la mèche 5 mm

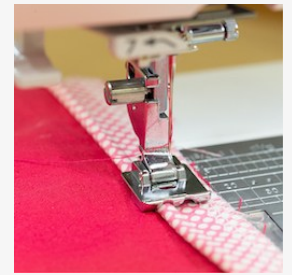
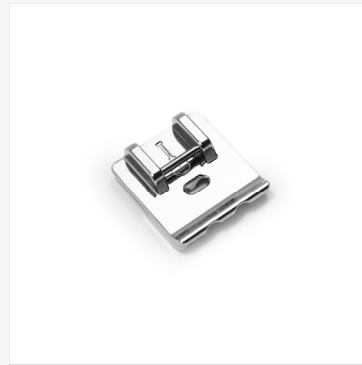

Ref.:202-088-200



680/+, 710, 720PRO, 730/PRO, 760/PRO, 770, 772, 780/+, 782, 790PRO/dressmaker, 792PRO, 850, 860, 900, 920

Pied pour pose de biais - pied à border (W)

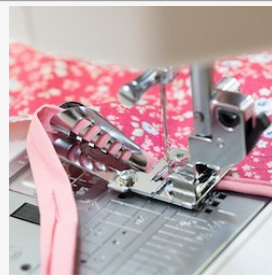

Ref.:202-099-204



680/+, 710, 720PRO, 730/PRO, 760/PRO, 770, 772, 780/+, 782, 790PRO, 792PRO, 850, 860, 900, 920

Pied pour pose de cordonnets (H)

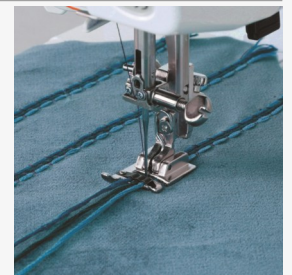
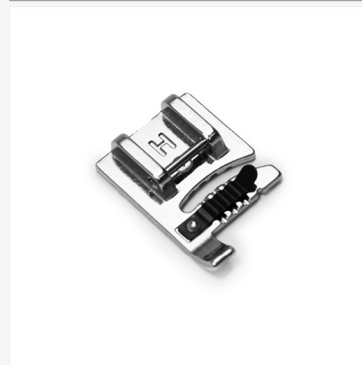

Ref.:202-085-207



680/+, 710, 720PRO, 730/PRO, 760/PRO, 770, 772, 780/+, 782, 790PRO/dressmaker, 792PRO, 850, 860, 900, 920

Pied pour pose de fermeture éclair invisible (Z)

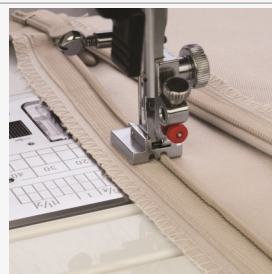

Ref.:202-156-004



680/+, 710, 720PRO, 730/PRO, 760/PRO, 770, 780/+, 850, 860, 900, 920

Pied pour pose de paillettes et de rubans (RS)

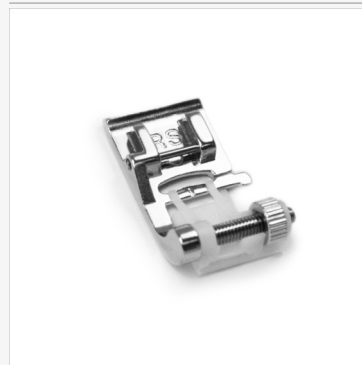

Ref.:202-090-205



680/+, 710, 720PRO, 730/PRO, 760/PRO, 770, 772, 780/+, 782, 790PRO/dressmaker, 792PRO, 850, 860, 900, 920

Pied pour pose de perles et de mèches de 2.5 à 4 mm (L2)

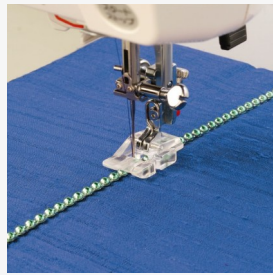

Ref.:202-098-203



680/+, 710, 720PRO, 730/PRO, 760/PRO, 770, 772, 780/+, 782, 790PRO/dressmaker, 792PRO, 850, 860, 900, 920

Pied pour pose de perles et de mèches jusqu'à 2 mm de diamètre (L1)

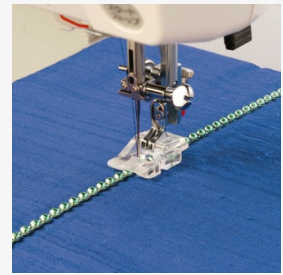

Ref.:202-097-202



680/+, 710, 720PRO, 730/PRO, 760/PRO, 770, 772, 780/+, 782, 790PRO/dressmaker, 792PRO, 850, 860, 900, 920

Pied pour règles à quilter avec support QB-S



Ref.:858-820-029



770, 780

Pied pour zigzag variable à fourche ouverte (QZ)



Ref.:862-895-006



770, 772, 780/+, 920

Pied professionnel ¼ de pouce HP



Ref.:865-803-006



720PRO, 770, 772, 780/+

Pied professionnel à double entraînement Dual Feed Plus avec support - système étroit (HP2)



Ref.:202-416-005



720PRO, 770, 772, 780/+, 920

Pied quilting en piqué libre à fourche fermée (QC)

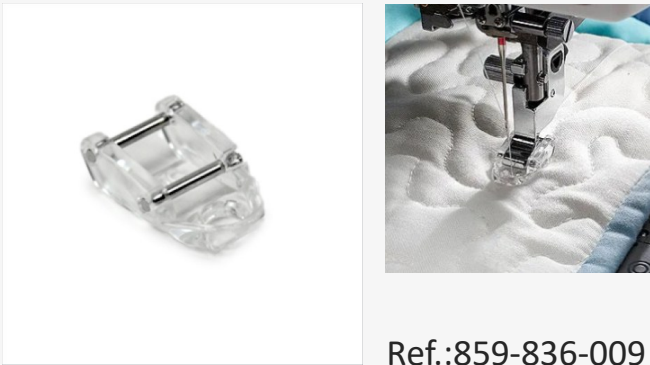

Ref.:859-836-009

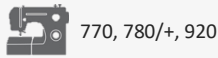

Pied quilting en piqué libre à fourche ouverte (QO)



Ref.:859-837-000

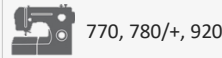

Pied quilting pour broderie à fil couché (FMC)



Ref.:202-142-007

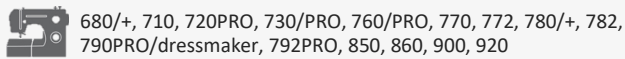

Pied satin à fourche ouverte (F2)



Ref.:859-813-000

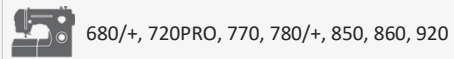

Pied satin avec guides intégrés (FB)

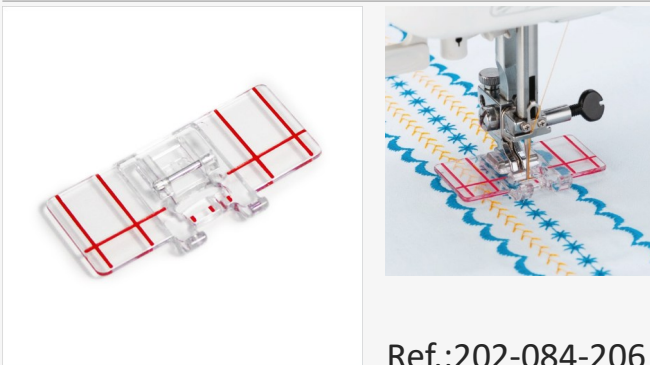

Ref.:202-084-206

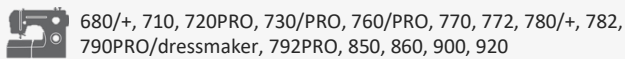

Pied transparent ¼ de pouce pour plaque aiguille pour points droits (OM)

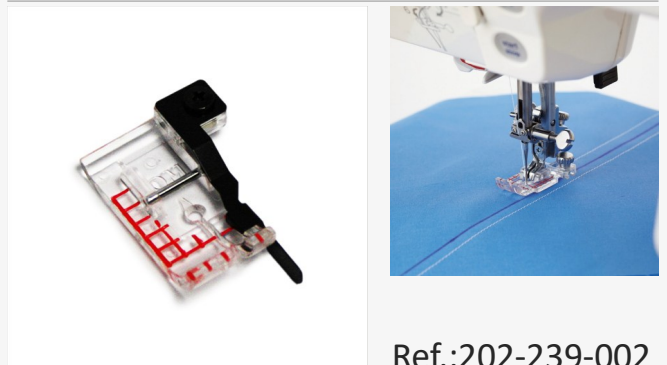

Ref.:202-239-002

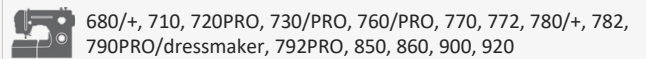

Pied transparent pour quilting en piqué libre (QV)



Ref.:859-812-009

770, 780/+, 920

Pied ultra-glisse antiadhérent (U)



Ref.:202-500-007

680/+, 710, 720PRO, 730/PRO, 760/PRO, 770, 772, 780/+, 782, 790PRO, 792PRO, 850, 860, 900, 920

Kit complet avec unité pour double transport



Ref.:202-234-007

680/+, 850, 860

Kit complet de pieds pour le quilting en piqué libre



Ref.:202-243-009

680/+, 720PRO, 730/PRO, 760/PRO, 770, 772, 780/+, 782, 790PRO, 792PRO, 850, 860, 900, 920

Kit de pieds pour le quilting en piqué libre



Ref.:767-434-016

680/+, 720PRO, 730/PRO, 760/PRO, 850, 860 - Only when using support 858-820-018

Pied transparent de quilting avec guides (OV)

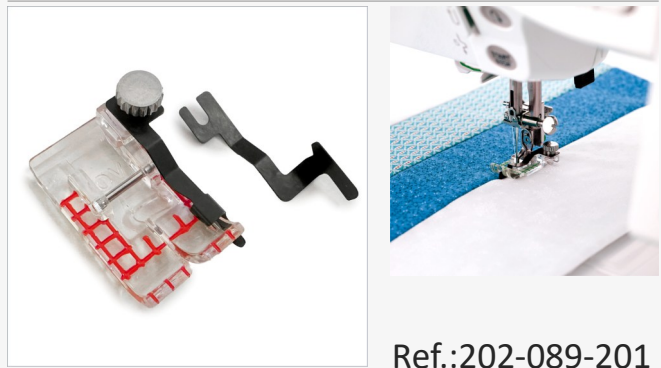

Ref.:202-089-201

680/+, 710, 720PRO, 730/PRO, 760/PRO, 770, 772, 780/+, 782, 790PRO/dressmaker, 792PRO, 850, 860, 900, 920

Pied ultra-glisse antiadhérent et plaque  
aiguille anti-adhérente

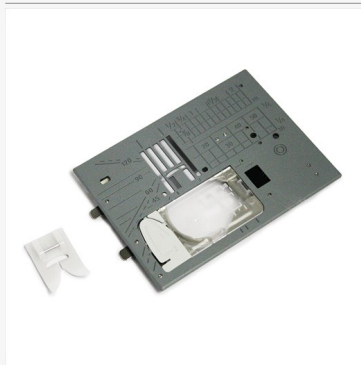

Ref.:202-237-000



680/+, 710, 720PRO, 730/PRO, 760/PRO, 770, 772, 780/+, 782, 850, 860, 900, 920

Pied ultra-glisse antiadhérent et plaque  
aiguille anti-adhérente



Ref.:202-497-000



790PRO/dressmaker, 792PRO

Guide de couture sur rubans - large



Ref.:200-444-419



680/+, 710, 720PRO, 730/PRO, 760/PRO, 770, 772, 780/+, 782, 790PRO/dressmaker, 792PRO, 850, 860, 920

Guide de matelassage

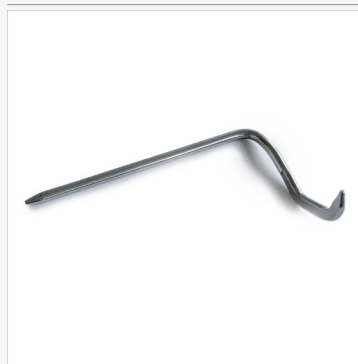

Ref.:755-802-001



680/+, 720PRO, 770, 780/+, 850, 860, 920

Guide étroit pour nervures renforcées par  
la pose de cordonnets (A)



Ref.:503-810-005



900

Guide large pour nervures renforcées par  
la pose de cordonnets (B)



Ref.:503-809-001



900

Guide-tissu



Ref.:858-401-008



770, 772

Guide-tissu



Ref.:859-825-016



850, 860, 900, 920

Guide-tissu T



Ref.:200-100-100



680/+, 720PRO, 770, 772, 780/+, 782, 792PRO, 850, 860, 920

Dispositif et pied pour pose de biais (W1)



Ref.:202-101-200

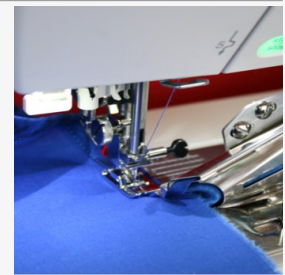

900

Dispositif et pied pour pose de biais (W1)



Ref.:202-245-001

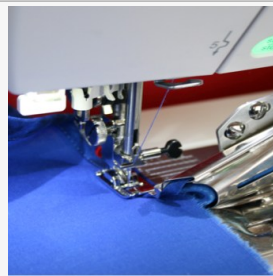

680/+, 710, 720PRO, 730/PRO, 760/PRO, 770, 772, 780/+, 782, 790PRO/dressmaker, 792PRO, 850, 860, 920

Guide de matelassage et guide pour couture centrale



Ref.:202-249-005



680/+, 850, 860

### Guides pour nervures renforcées par la pose de cordonnets - large et étroit



Ref.:202-238-001



680/+, 710, 720PRO, 730/PRO, 760/PRO, 770, 772, 780/+, 782, 790PRO/dressmaker, 792PRO, 850, 860, 920

### Longs guides de matelassage



Ref.:202-025-405



680/+, 710, 720PRO, 730/PRO, 760/PRO, 770, 772, 780/+, 782, 790PRO/dressmaker, 792PRO, 850, 860, 900, 920

### Plaque aiguille pour couture droite



Ref.:861-801-013



850, 860

### Plaque aiguille professionnelle HP

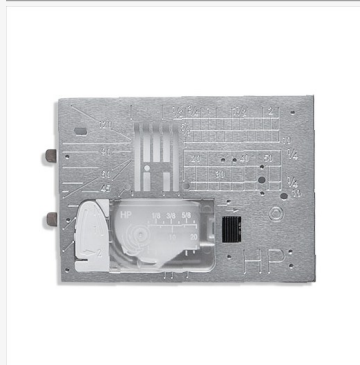

Ref.:865-805-019



720PRO, 770, 772, 780/+

### Capsule spéciale basse-tension pour quilting en piqué libre

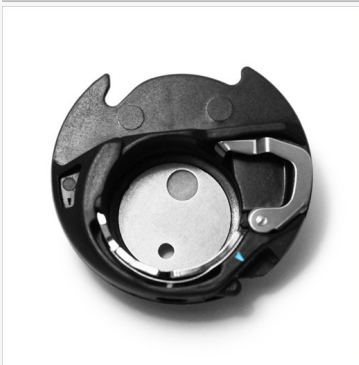

Ref.:200-445-029



680/+, 710, 720PRO, 730/PRO, 760/PRO, 770, 772, 780/+, 782, 850, 860, 900, 920

### Guide pour couture circulaire



Ref.:202-242-008



680/+, 710, 720PRO, 730/PRO, 760/PRO, 770, 772, 780/+, 782, 790PRO/dressmaker, 792PRO, 850, 860, 900, 920

## Kit pour fonctionnalités avancées pour eXcellence 770 et 780 contenant:

Mise-à-jour logiciel et 4 pieds-de-biche

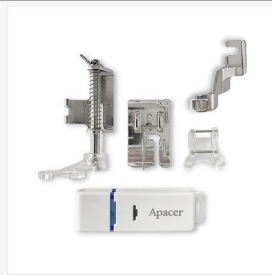

Ref.:865-403-002

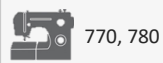

770, 780

## Logiciel Stitch Composer

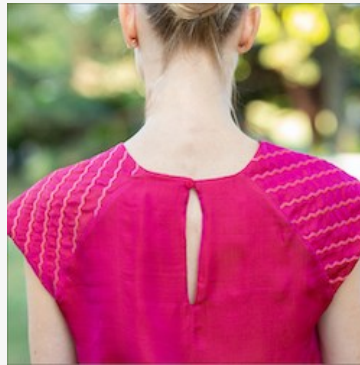

Ref.:861-827-004



770

## Loupe optique amovible (1.2x)



Ref.:202-399-001

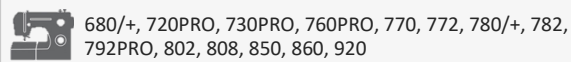

680/+, 720PRO, 730PRO, 760PRO, 770, 772, 780/+, 782, 792PRO, 802, 808, 850, 860, 920

## Kit loupes optiques amovibles.

Set de trois loupes optiques 1.2x, 1.4x et 1.6x.

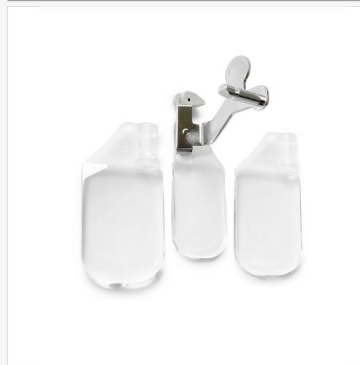

Ref.:202-157-005



680/+, 710, 720PRO, 730/PRO, 760/PRO, 770, 772, 780/+, 782, 802, 808, 850, 860, 900, 920

## Kit loupes optiques amovibles.

Set de trois loupes optiques 1.2x, 1.4x et 1.6x.



Ref.:202-496-009



790PRO/dressmaker, 792PRO





## ACCESSOIRES POUR LA BRODERIE

Pour les machines à coudre et à broder combinées et  
pour les brodeuses

Nos modèles de machines à coudre et à broder combinées et de brodeuses valorisent au plus près de leurs capacités les possibilités de cette discipline qu'est la broderie. Une même création peut se métamorphoser grâce à des motifs de broderie qui vont entièrement personnaliser vos projets de confection et de décoration, ainsi que vos accessoires.

Tous les motifs de broderie inclus sont minutieusement étudiés pour obtenir des résultats irréprochables et une régularité à toute épreuve. Nos accessoires de broderie vont vous permettre d'élargir vos possibilités grâce à des cerceaux en option, mais également d'aménager votre environnement de travail pour vous simplifier la tâche!



Les modèles de brodeuses concernés par cette catégorie sont:

eXpressive 802 et 808  
eXpressive 820 (elna 8200 et 8300)  
eXpressive 830 et 830L *incluant Creative Edition*  
eXpressive 850 et 860  
eXpressive 900  
eXpressive 920  
eXpressive 940 (elna 9900)  
eXpressive 970

N.B. : les anciens modèles correspondants aux modèles de la gamme actuelle sont indiqués entre parenthèses.

Canette large



Ref. :770-591-001



970

Cônes guide-fil pour broderie à fil couché



Ref. :862-410-508



Additional guide for embroidery couching foot set  
202-394-006

Kit de pieds pour broderie à fil couché



Ref. :202-394-006



802, 830/L, 920

Guide-tissu

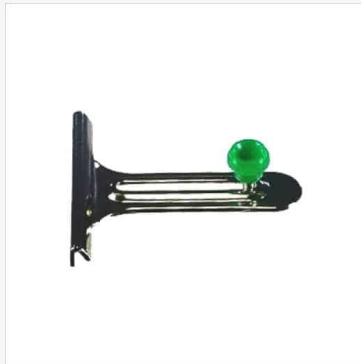

Ref. :200-100-708



808

Cerceau ovale pour broderie sur casquette – 100 x 90 mm



Ref. :859-436-005



900, 920

Cerceau pour broderie sur casquette plate



Ref. :770-489-025



940, 970

Cerceau rectangulaire pour broderie sur casquette - 100 x 90 mm



Ref. :200-335-023



820, 830/L

Adaptateur pour cerceaux Monogrammes J1 à J8



Ref. :770-482-008



940, 970

Cerceau pour monogramme J1 n°11 - 30 mm diamètre



Ref. :770-487-704



940, 970

Cerceau pour monogramme J1 n°12 - 30 mm diamètre



Ref. :770-487-807



940, 970

Cerceau pour monogramme J2 n°6 - 25 x 54 mm



Ref. :770-487-302



940, 970

Cerceau pour monogramme J3 n°13 - 64 x 28 mm

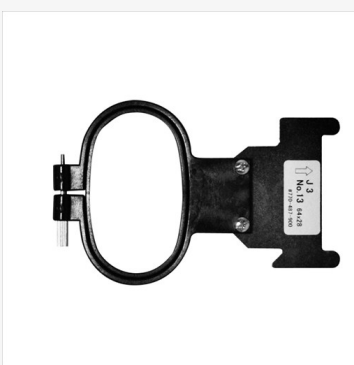

Ref. :770-487-900



940, 970

Cerceau pour monogramme  
J4 n°8 - 42 x 67 mm



Ref. :770-487-508

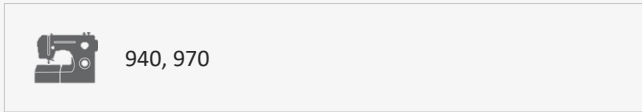

Cerceau pour monogramme  
J5 n°3 - 46 x 46 mm



Ref. :770-487-209

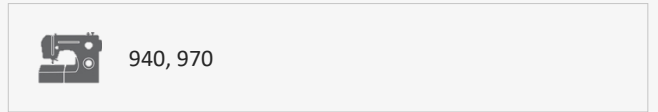

Cerceau pour monogramme  
J6 n°2 - 66 x 66 mm



Ref. :770-487-106

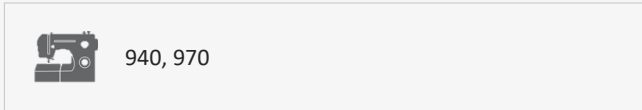

Cerceau pour monogramme  
J6 n°9 - 66 x 66 mm



Ref. :770-487-601

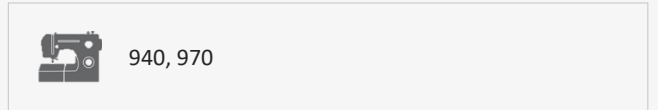

Cerceau pour monogramme  
J7 n°1 - 110 x 95 mm



Ref. :770-487-003

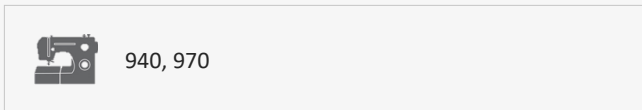

Cerceau pour monogramme  
J8 n°7- 120 x 121 mm



Ref. :770-487-405

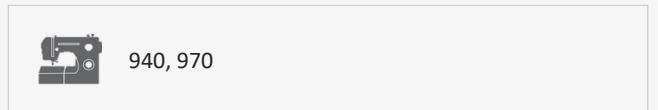

Kit de cerceaux pour broderie sur chaussettes



Ref. :770-480-006



940, 970

Cerceau bras libre - FA10a - 100 x 40 mm



Ref. :861-407-004



850, 860

Cerceau bras libre FA10e – 100 x 40 mm



Ref. :819-409-005



802, 808

Cerceau bras libre FA5e – 50 x 50 mm



Ref. :819-410-009



802, 808

Cerceau carré grand - SQ20b  
200 x 200 mm



Ref. :864-412-001



830/L

Cerceau carré petit - SQ14b  
140 x 140 mm



Ref. :864-414-003



830/L

Cerceau rectangulaire  
RE18 - 140 x 180 mm



Ref. :859-451-006

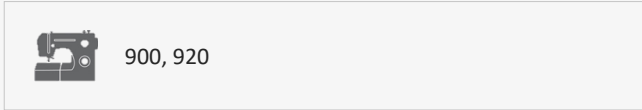

Cerceau rectangulaire grand  
M1 – 240 x 200 mm



Ref. :770-807-003

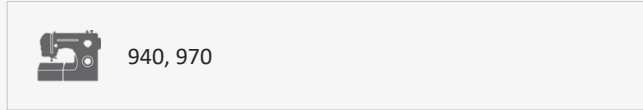

Cerceau rectangulaire grand - RE28b - 200  
x 280 mm



Ref. :864-411-000

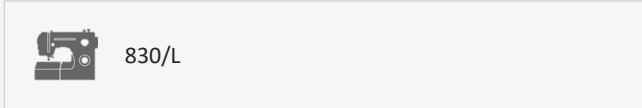

Cerceau rectangulaire mini  
RE10B - 100 x 40 mm



Ref. :864-415-004

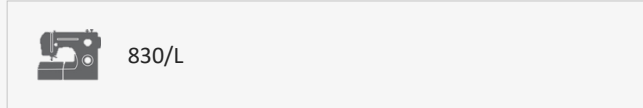

Cerceau rectangulaire moyen  
M2 – 126 x 100 mm

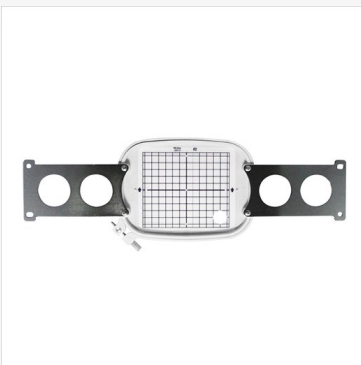

Ref. :770-808-004

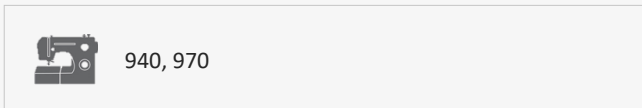

Cerceau rectangulaire petit  
RE20b - 140 x 200 mm



Ref. :864-413-002

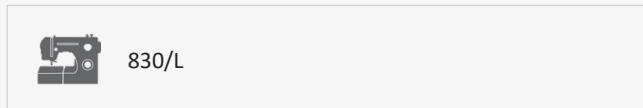

Broderie

Cerceau SQ10b – 10 x 10 cm



Ref. :864-438-014



830, 830L

Cerceau SQ10e – 100 x 100 mm



Ref. :819-408-004



802, 808

Kit de quilting avec cerceau carré  
ASQ18B - 184 x 184 mm



Ref. :864-410-009



830

Kit de quilting avec cerceau carré  
ASQ18B - V2.3 mise à jour

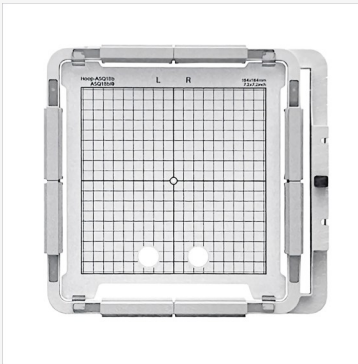

Ref. :864-436-001



830/L

Kit de quilting avec cerceau carré  
ASQ22 - 220 x 220 mm



Ref. :862-413-006



920

Petit cerceau – M3 – 50 x 50 mm



Ref. :770-809-005



940, 970

## Capsule spéciale pour broderie



Ref. :202-253-002



802, 808, 830/L, 850, 860, 900, 920

## Collection de grands motifs de broderie



Ref. :202-296-007



900, 830/L, 920

**Kit de broderie Cutwork:** Disponible bientôt  
4 aiguilles Cutwork, porte-aiguilles Cutwork et des motifs de broderie Cutwork à télécharger sur notre site internet.

## Kit pour broderie à fil couché et brossé



Ref. :202-574-105



802, 808, 920



Ref. :200-383-028



802, 808, 830/L, 850, 860, 920

Broderie

## Lecteur CD-Rom et DVD



Ref. :860-429-009



820, 970

## Positionneur 1



Ref. :859-442-200



830/L, 850, 860, 900, 920

## Ruban antidérapant pour cerceau de broderie

---



Ref. :864-813-006



830/L, 802, 808, 850, 920, 970





## ACCESSOIRES OPTIONNELS

### Surjeteuses et recouvreuses

Pour les amateurs de finitions solides et soignées, les surjeteuses et recouvreuses sont indispensables. En effet, ces dernières vous offrent non seulement des finitions parfaites, mais également la possibilité de travailler des matières stretch beaucoup plus facilement qu'avec une machine à coudre classique. La vaste collection d'accessoires en option pour nos surjeteuses et recouvreuses va vous permettre de découvrir toutes les possibilités qu'offrent ces machines à coudre parfois méconnues. Les ourlets, les fronces et la pose de biais n'auront plus de secrets pour vous!



Les modèles de surjeteuses et recouvreuses concernés par cette catégorie sont:

eXtend 264  
eXtend 664 et 664PRO  
eXtend 745 et 845  
eXtend 864*air*  
eXtend *easycover*  
eXtend *covermax* (elna 434 et 444)

N.B. : les anciens modèles correspondants aux modèles de la gamme actuelle sont indiqués entre parenthèses.

Pied à froncer



Ref. :200-248-008



264, 664/PRO, 864air

Pied à froncer avec guide



Ref. :200-807-001



745, 845

Pied ajustable pour pose de biais (M)



Ref. :200-810-007



745, 845

Pied avec guide de couture centrée



Ref. :795-819-119



easycover, covermax

Pied d'attache en métal

(inclus dans les kits 795-838-114 et 795-844-032)



Ref. :795-825-004



easycover, covermax

Pied d'attache transparent avec guide (

ce pied est inclus dans les sets n. 202-403-009 et 202-404-000)



Ref. :796-402-004



easycover, covermax

### Pied multi-usages



Ref. :200-805-009



745, 845

### Pied ourlet couvert supérieur (R)



Ref. :797-812-004



845

### Pied passepoil de 1/8 de pouce



Ref. :200-219-123



264, 864,air, 664/pro

### Pied pour création de brides



Ref. :200-808-002

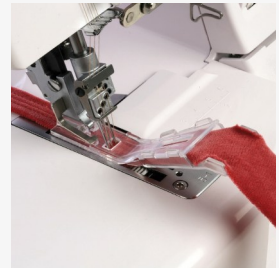

745, 845

### Pied pour nervures ou pose de cordonnets (K)



Ref. :200-802-202

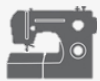

745, 845

### Pied pour ourlet couvert (M)



Ref. :200-801-304



745, 845

Pied pour ourlet invisible (D)



Ref. :202-040-015

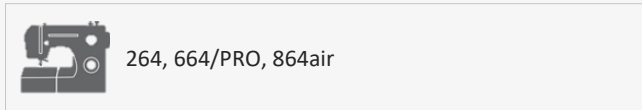

Pied pour ourlet invisible (D)



Ref. :202-255-004

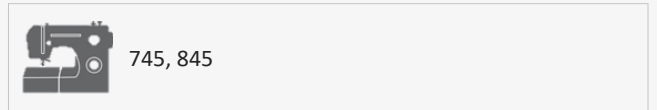

Pied pour passepoil (E)



Ref. :200-814-104

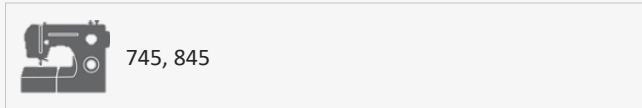

Pied pour pose de cordonnets de type A



Ref. :202-034-016

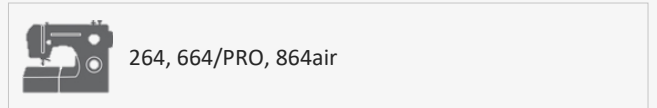

Pied pour pose de cordonnets de type B

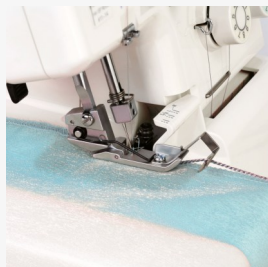
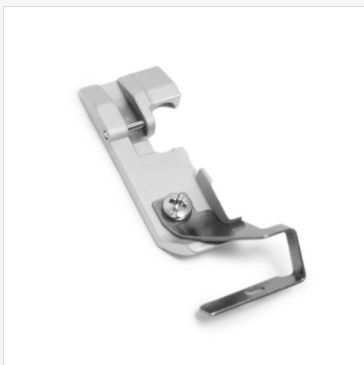

Ref. :202-035-017

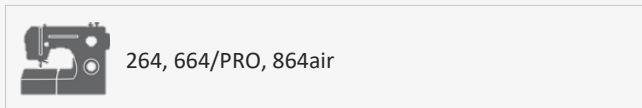

Pied pour pose de perles et de mèches avec guide



Ref. :202-041-119

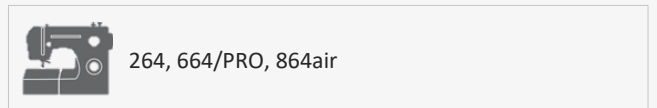

### Pied pour pose de rubans (Q)

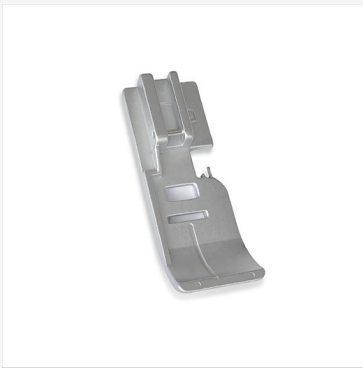

Ref. :496-245-20



745, 845

### Pied transparent pour ourlet couvert



Ref. :795-818-118



easycover, covermax

### Pied transparent pour ourlet couvert (N)



Ref. :200-804-101



745, 845

### Pied transparent pour point chaînette et ourlet couvert (F)



Ref. :200-803-306



745, 845

### Pied transparent pour pose de perles et de mèches

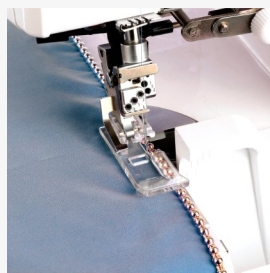

Ref. :200-809-003



745, 845

### Pieds passepoil à 1/8 et 3/16 de pouce



Ref. :202-039-011



264, 664/PRO, 864air

Kit pour ourlet couvert avec ses 3 guides : H-1, H-2 et H-3



Ref. :202-254-003

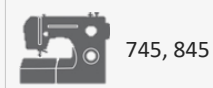

Pied multi-usages avec 3 guides fronceur pour élastique



Ref. :202-248-004

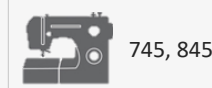

Guide de couture ajustable

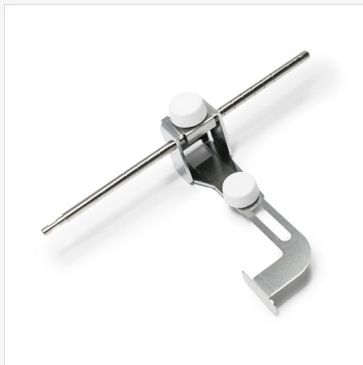

Ref. :795-806-113

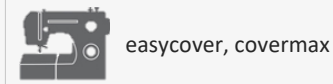

Guide en métal pour pied à froncer



Ref. :202-036-111

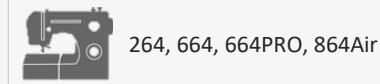

Guide fil pour cônes industriels



Ref. :200-811-008

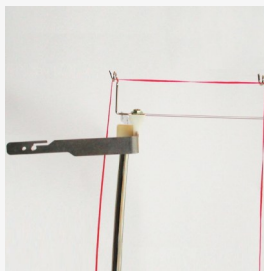
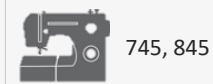

Guide pour biais et plieuse pour pose de ceinture

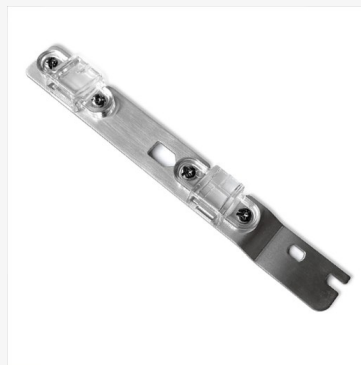

Ref. :202-491-004

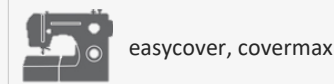

### Guide pour cordonnet

*(doit être utilisé avec le pied art. 200-802-202)*



Ref. :200-802-305



745, 845

### Guide pour couture ouverte (N-1)

*(doit être utilisé avec le pied art. 200-804-101)*



Ref. :200-804-008



745, 845

### Guide pour couture rabattue (F-4)

*(doit être utilisé avec le pied art. 200-803-306)*



Ref. :200-803-203



745, 845

### Guide pour coutures courbés



Ref. :200-812-009



745, 845

### Guide pour dentelle ou bordure (F-3)

*(doit être utilisé avec le pied art. 200-803-306)*



Ref. :200-803-100



745, 845

### Guide pour faux-jour (F-2)

*(doit être utilisé avec le pied art. 200-803-306)*



Ref. :200-803-007



745, 845

### Guide pour nervures

(doit être utilisé avec le pied art. 200-802-202)



Ref. :200-802-006

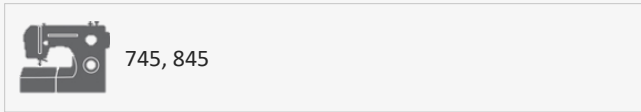

### Guide pour ourlet couvert



Ref. :795-839-115

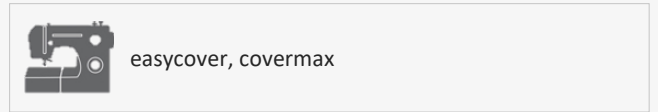

### Guide pour ourlet couvert (H-2)

(doit être utilisé avec le pied art. 200-801-304)



Ref. :200-801-108

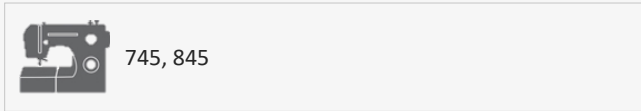

### Guide pour pose de biais

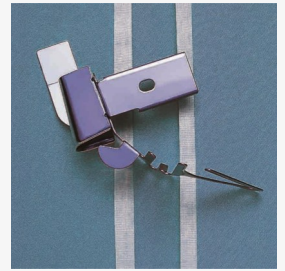

Ref. :200-814-001

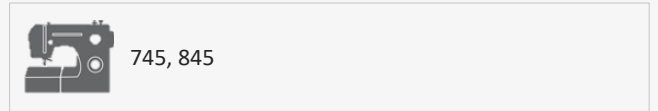

### Guide pour pose de biais en bordure (H-3)

(doit être utilisé avec le pied art. 200-801-304)

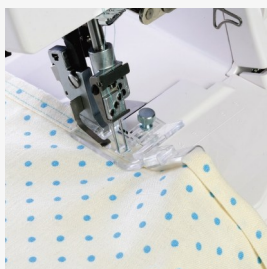

Ref. :200-801-201

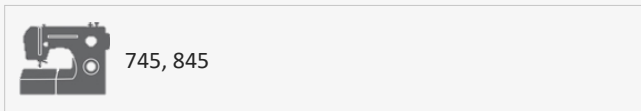

### Guide pour pose de biais étroit et pied d'attache en métal

(pied disponible séparément art. 795-825-004)

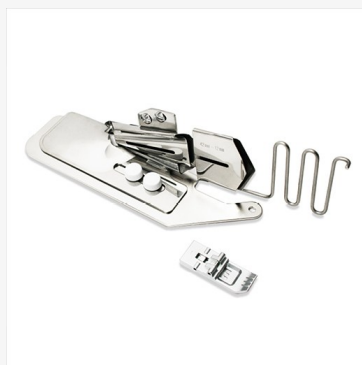

Ref. :795-838-114

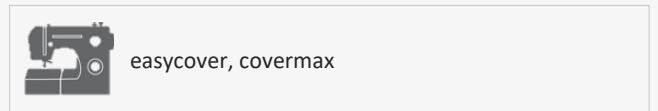

### Guide pour pose de biais étroit et pied d'attache transparent (8mm)

(pied disponible séparément art. 796-402-004)



Ref. :202-403-009



easycover, covermax

### Guide pour pose de biais large et pied d'attache en métal

(pied disponible séparément art. 795-825-004)



Ref. :795-844-032



easycover, covermax

### Guide pour pose de biais large et pied d'attache transparent (12mm)

(pied disponible séparément art. 796-402-004)



Ref. :202-404-000



easycover

### Guide pour pose de dentelle en bordure (H-1)

(doit être utilisé avec le pied art. 200-801-304)



Ref. :200-801-005



745, 845

### Guide supérieur rond pour ourlet couvert supérieur



Ref. :797-343-009



845

### Guide-tissu



Ref. :202-038-010



264, 664/PRO, 864air

Guide-tissu gradué



Ref. :396-001-42

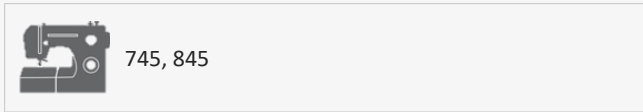

Crochet pour ourlet couvert supérieur



Ref. :797-342-008

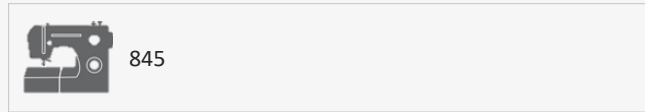

Fronceur élastique



Ref. :202-037-019

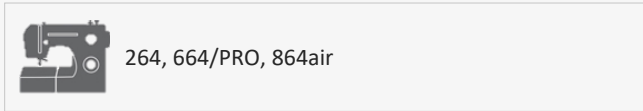

Fronceur élastique - étroit

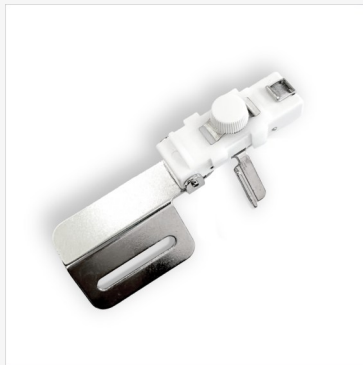

Ref. :795-816-116

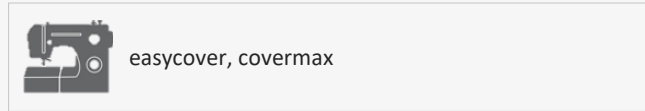

Fronceur élastique - large



Ref. :795-817-117

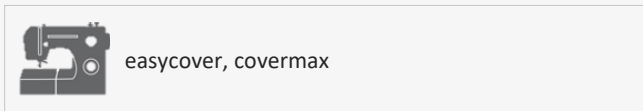

Guide fronceur pour élastique - 10 mm de largeur

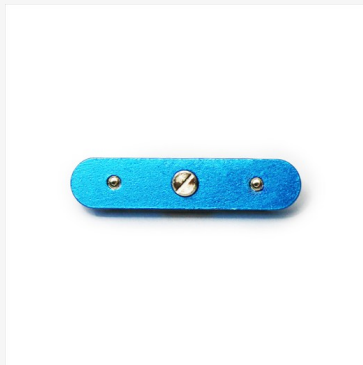

Ref. :200-805-205

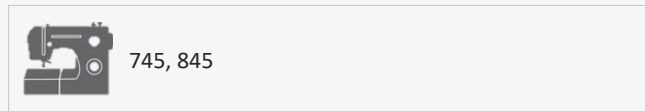
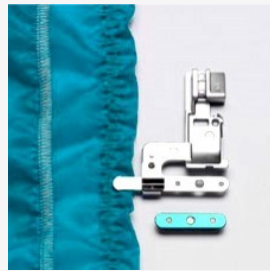

Guide fronceur pour élastique  
13 mm de largeur



Ref. :200-805-308

Guide fronceur pour élastique  
7.5 mm de largeur



Ref. :200-805-102

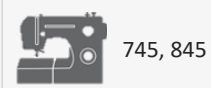

745, 845



745, 845

Récipient pour chutes de tissus et déchets



Ref. :202-460-004



Ref. :797-866-106



264

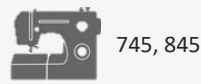

745, 845

Récipient pour chutes de tissus et déchets  
(design 2022)



Ref. :798-042-A01

Set pour pose de rubans

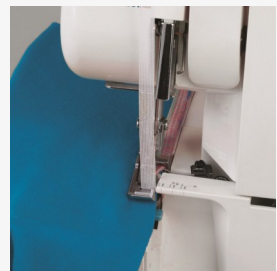

Ref. :202-033-015



664/PRO

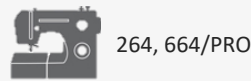

264, 664/PRO

### Support de fixation pour accessoires



Ref. :200-812-102

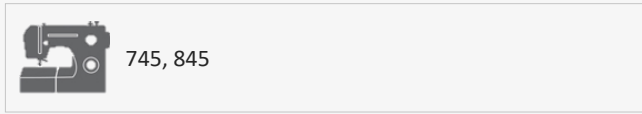

### Table d'extension



Ref. :202-443-001

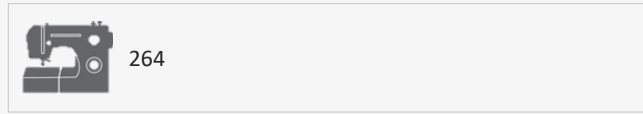

Surjeteuse et recouvreuse

elna  
SWISS DESIGN





## ACCESSOIRES ET ARTICLES GÉNÉRAUX

Cette catégorie regroupe tous les articles qui vous seront indispensables pour une utilisation optimale de votre machine à coudre elna.

Des canettes aux tables de couture, en passant par les sacs de transport, ces accessoires vous permettront d'améliorer votre environnement de travail et surtout, de vous faciliter la tâche!



Cette catégorie concerne tous les modèles de machines à coudre, de brodeuses, de surjeteuses et de recouvreuses elna.

Sac de transport à roulettes elna  
L 56cm x H 45cm x P 34cm

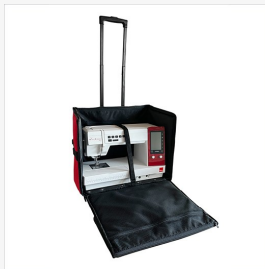

Ref. :395-800-01



320/S, 340/S, 3210j, Lotus/2, 450, 520/S, 540/S, 530, 550, 560, 570/α, 580/+, 680/+, 710, 720PRO, 770, 772, 780/+, 782, 802, 808, 850, 860,

Sac pour accessoires elna  
33 x 26 cm (LxH)



Ref. :395-800-03



Universal

Pochette additionnelle pour le sac  
accessoires elna (L: 48 cm x H: 30.50 cm)



Ref. :395-800-04



Additional storage for accessory bag 395-800-03

Coffret de rangement accessoires – grand  
modèle



Ref. :866-801-018



Universal

Coffret de rangement accessoires - petit  
modèle



Ref. :843-823-004



Universal

Coque de protection (43,6 x 20,1 cm)



Ref. :404-701-404



530, 550, 560, 570/α,

Housse de protection



Ref. :395-731-78



3210J

Housse de protection



Ref. :396-601-16



easycover, covermax

Housse de protection



Ref. :741-811-000



Sew, 220/S, 240/S

Housse de protection



Ref. :864-807-100



830/L

Housse de protection semi-rigide 415 x 320 x 280 mm (LxHxP)



Ref. :849-804-007



450, 520/S, 540/S, 530, 560, 570/α

Housse de protection semi-rigide 480 x 340 x 250 mm (LxHxP)



Ref. :846-831-004



720, 3210J

Housse de protection semi-rigide 520 x 340 x 360 mm (LxHxP)



Ref. :861-806-100



850, 860

Housse de protection semi-rigide 540 x 340 x 260 mm (LxHxP)



Ref. :858-802-069



580/+, 680/+, 730/PRO, 760/PRO, 710, 770, 772, 780/+, 782

Sac de transport avec broderie elna

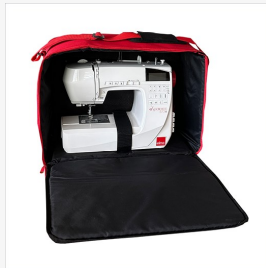

Ref. :849-802-005



Sew, 150, 160, 220/S, 240/S, 320/S, 340/S, 3210j, Star, Lotus/2, 450, 520/S, 540/S, 530, 550, 560, 570/α, covermax, easycover

Capsule basse-tension pour quilting en piqué libre



Ref. :202-495-008



790PRO, 792PRO/dressmaker

Porte-canette métallique



Ref. :395-710-08



Sew, 220/S, 240/S

Porte-canette métallique



Ref. :770-590-000



970

### Canette elna



Ref. :395-751-83



Universal

### Canette elna "easy bobbin" (1pce)



Ref. :202-192-404



Sew, 150, 160, 220/S, 240/S, 320/S, 340/S, 3210j, Star, Lotus/2, 450, 520/S, 540/S, 530, 550, 560, 570/α, 710, 720PRO, 730/PRO, 760/PRO, 770, 772,

### Canettes elna "easy bobbin" (x10)



Ref. :202-260-002



Sew, 150, 160, 220/S, 240/S, 320/S, 340/S, 3210j, Star, Lotus/2, 450, 520/S, 540/S, 530, 550, 560, 570/α, 710, 720PRO, 730/PRO, 760/PRO, 770, 772,

### Canettes elna (10pcs)

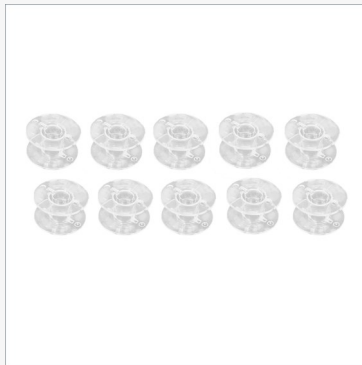

Ref. :200-122-027



Universal

Général

### Clé USB



Ref. :395-741-60



770, 780/+, 830/L, 850, 860, 900, 920, 970

### Dispositif pour pédale coupe-fil avec plaque de base



Ref. :858-418-008



680/+, 720PRO, 730/PRO, 760/PRO, 770, 772, 780/+, 782, 790PRO, 792PRO, 808, 850, 860

### Pédale de contrôle - large



Ref. :858-417-007



Star, 450, 520/S, 540/S, 530, 550, 560, 570/α, Lotus/2, 580/+, 680/+, 710, 720PRO, 730/PRO, 760/PRO, 770, 772, 780/+, 808, 850, 860, 900

### Protection pour doigts

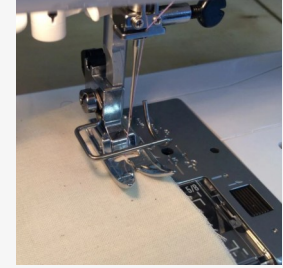

Ref. :687-803-008



Sew, 150, 160, 220/S, 240/S, 320/S, 340/S, 3210j, Star, Lotus/2, 450, 520/S, 540/S, 530, 550, 560, 570/α, 580/+, 680/+, 720PRO, 760/PRO, 770, 772,

### Fourche à tapis

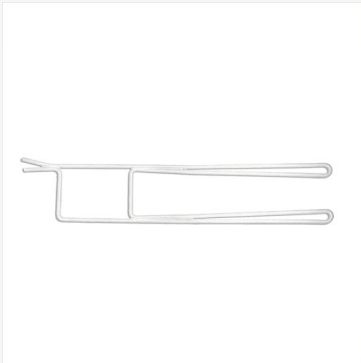

Ref. :424-630-10



Universal

### Genouillère



Ref. :846-417-022



770, 772, 808

### Plaque élévatrice pour boutons



Ref. :832-820-007



Sew, 150, 160, 220/S, 240/S, 320/S, 340/S, 3210j, Star, Lotus/2, 450, 520/S, 540/S, 530, 550, 560, 570/α, 580/+, 680/+, 710, 720PRO, 770, 772, 780/

### Point pivot pour couture circulaire

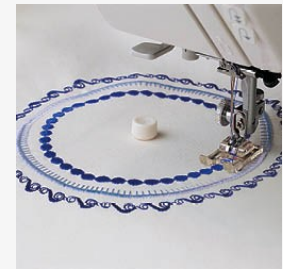

Ref. :849-801-004



220/S, 240/S, 620, 660, 580/+, 680/+, 730/PRO, 760/PRO, 770, 772, 780/+, 782, 850, 860, 920

Support de rubans  
(pour guide pour pose de biais)



Ref. :202-402-008



Lotus, Lotus/2, 580/+, 680/+, 710, 720, 720PRO, 770, 772, 780/+, 782, 790PRO/dressmaker, 792PRO, 850, 860, 920, easycover, covermax

Tapis elna - 44.5 x 32.5 cm



Ref. :301-804-004



Sew, 150, 160, 220/S, 240/S, 320/S, 340/S, 3210j, Star, Lotus/2, 450, 520/S, 540/S, 530, 550, 560, 570/α, 264, 664/PRO, 745, 845, 864air, easycover,

Tapis elna - large (685 x 425mm)



Ref. :301-804-107



580/+, 680/+, 730/PRO, 760/PRO, 770, 772, 780/+, 782, 790PRO/dressmaker, 792PRO, 830/L, 850, 860, 900, 920

Disque fixe-bobine: grand modèle



Ref. :822-020-503



150, 160, 320/S, 340/S, 3210j, Star, 450, 520/S, 540/S, 530, 550, 560, 570/α, 580/+, 680/+, 710, 720PRO, 730/PRO, 760/PRO, 770, 780/+, 782,

Disque fixe-bobine: modèle spécial



Ref. :202-240-006



150, 160, 320/S, 340/S, 3210j, Star, 450, 520/S, 540/S, 530, 550, 560, 570/α, 580/+, 680/+, 710, 720PRO, 730/PRO, 760/PRO, 770, 780/+, 772, 782,

Disque fixe-bobine: petit modèle

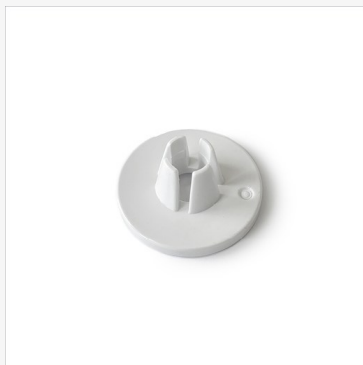

Ref. :822-019-509



150, 160, 320/S, 340/S, 3210j, Star, 450, 520/S, 540/S, 530, 550, 560, 570/α, 580/+, 680/+, 710, 720PRO, 730/PRO, 760/PRO, 770, 780/+, 782,

Porte-bobine - 2 bobines / cônes



Ref. :202-513-003



Sew, 220/S, 240/S

Porte-bobine - 2 bobines / cônes



Ref. :859-449-012



580/+, 680/+ 730/PRO, 760/PRO, 770, 772, 780/+, 782, 792PRO, 802, 808, 830/L, 850, 860, 900, 920

Porte-bobine - 2 bobines / cônes



Ref. :869-400-908



772, 782

Porte-bobine - 5 bobines / cônes



Ref. :859-450-005



580/+, 680/+ 770, 772, 780/+, 782, 792PRO, 830/L, 802, 808, 850, 860, 900, 920

Général

Porte-bobine pour 2 bobines / cônes



Ref. :858-408-005



710

Coussin à épingles - blanc



Ref. :202-256-016



150, 160, 320/S, 340/S, 3210j, 450, 520/S, 540/S, 530, 550, 560, 570/α, 580/+, 680/+, 770, 772, 780/+, 782, 792PRO, 850, 860, 920

Coussin à épingles - jaune



Ref. :202-256-038



150, 160, 320/S, 340/S, 3210j, 450, 520/S, 540/S, 530, 550, 560, 570/α, 580/+, 680/+, 770, 772, 780/+, 782, 792PRO, 850, 860, 920

Coussin à épingles - mauve



Ref. :202-256-027



150, 160, 320/S, 340/S, 3210j, 450, 520/S, 540/S, 530, 550, 560, 570/α, 580/+, 680/+, 770, 772, 780/+, 782, 792PRO, 850, 860, 920

Coussin à épingles - rose



Ref. :202-256-005



150, 160, 320/S, 340/S, 3210j, 450, 520/S, 540/S, 530, 550, 560, 570/α, 580/+, 680/+, 770, 772, 780/+, 782, 792PRO, 850, 860, 920

Table d'extension extra-large



Ref. :819-407-003



802, 808

Broche porte-bobine supplémentaire



Ref. :395-710-23



Lotus/2

Table d'extension extra-large (40.5cm x 28cm)



Ref. :811-806-002



530, 550, 560, 570/α

Table d'extension extra-large et guide de couture (62cm x 42cm)



Ref. :858-419-010



710, 730/PRO, 760PRO

Table d'extension extra-large pour 3210 designed for jeans



Ref. :506-803-004



3210j

Table d'extension pour brodeuse multi-aiguille (43cm x 38cm)



Ref. :770-814-003



940, 970

Table d'extension transparente extra-large (62x 42 cm)



Ref. :865-812-008



770, 772, 780/+

Table d'extension transparente extra-large 50cm x 31cm



Ref. :861-406-025



580/+, 680/+ 850, 860

Table de couture avec tiroir et sans plateaux d'intégration



Ref. :494-719-002



790PRO/dressmaker, 792PRO

Table de couture sans plateaux d'intégration



Ref. :399-000-78



730/PRO, 740, 760/PRO

Table d'extension



Ref. :489-709-508



720

Table d'extension (40cm x 28cm)



Ref. :502-403-008



450

Table d'extension (45.5cm x 24,5cm)



Ref. :491-701-138



520/S, 540/S

Table d'extension pour recouvreuse (29.5cm x 20.5cm)



Ref. :795-812-307



easycover, covermax

Module optionnel avec tiroir pour table de couture 494-708-101



Ref. :494-708-204



580/+, 680/+, 710, 720, 720PRO, 730PRO, 760PRO, 770, 772, 780/+, 782, 850, 860, 900, 920

Général

Pochettes de rangement pour table de couture



Ref. :494-805-006



Universal

Table de couture avec tiroir et plateaux A,B et C



Ref. :494-711-004



710, 720, 730PRO, 760PRO, 900

Table de couture avec tiroir et sans plateaux d'intégration



Ref. :494-710-003



580/+, 680/+, 720, 720PRO, 730PRO, 760PRO, 770, 772, 780/+, 782, 850, 860, 900, 920

Table de couture sans tiroir et sans plateaux d'intégration



Ref. :494-708-101



580/+, 680/+, 710, 720, 720PRO, 730PRO, 760PRO, 770, 772, 780/+, 782, 850, 860, 900, 920

Table de travail sans espace pour le plateau d'intégration 115 x 45 x 76 cm



Ref. :494-709-009



Universal

Plateau d'intégration A



Ref. :494-401-101



710, 730PRO, 760PRO, 900

Plateau d'intégration B



Ref. :494-402-102

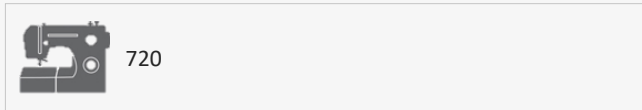

Plateau d'intégration D



Ref. :494-405-105

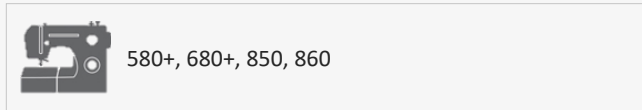

Plateau d'intégration E



Ref. :494-406-106

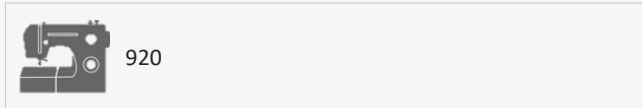

Plateau d'intégration G



Ref. :494-408-108

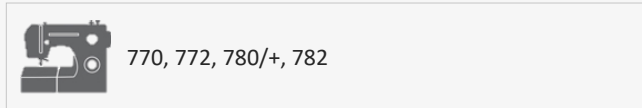

Plateau d'intégration H



Ref. :494-712-005

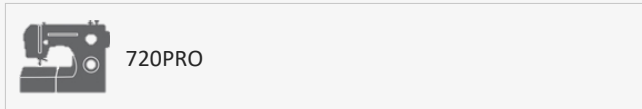

Plateau d'intégration K



Ref. :494-411-104

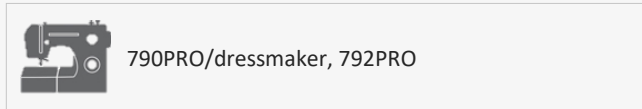

### Burette d'huile



Ref. :741-814-003



Universal

### Découd-vite



Ref. :200-133-021



Universal

### Enfile boucleur inférieur



Ref. :784-806-005



264

### Enfile-aiguille manuel universel



Ref. :200-347-020



Universal

### Pince brucelles



Ref. :624-801-001



Universal

### Pinceau de nettoyage



Ref. :802-424-004



Universal

Tournevis - fin



Ref. :647-803-004

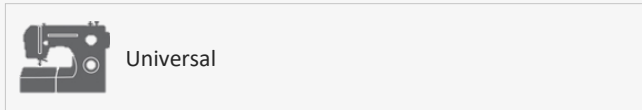

Tournevis - Petit



Ref. :820-832-005

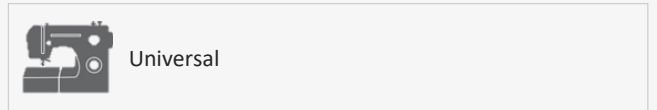

Kit d'aiguilles Cutwork: 0°, 45°, 90°, 135°



Ref. :202-298-009

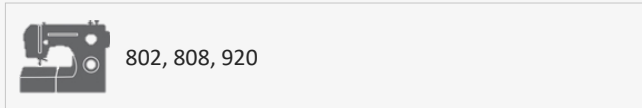

Set d'aiguilles jumelées universelles: 1x aiguille jumelée, 2x 75/11, 1x 90/14, 1x



Ref. :200-343-026

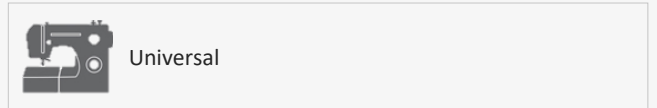

Général

Set d'aiguilles universelles: 2x 75/11, 1x aiguille à tête bleue, 2x 90/14



Ref. :200-135-023

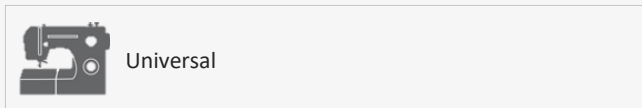

Set d'aiguilles à tête bleue: 75/11 - pour tissus synthétiques

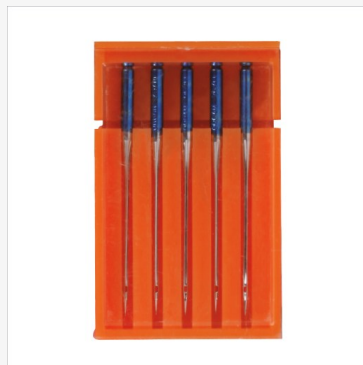

Ref. :200-346-029

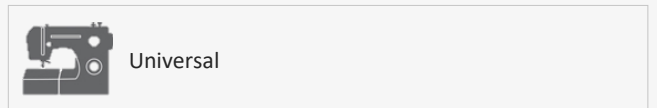

Set d'aiguilles à tête rouge: Pour tissus moyen à épais - taille 90/14



Ref. :990-314-132



Universal

Set d'aiguilles à tête violette: pour tissu épais ou maille - taille 90/14



Ref. :202-244-000



Universal



# AIGUILLES STANDARD POUR REMPLACEMENT DE ROUTINE

## AIGUILLES

### Catégorie - Modèles - Références

5-7 mm	Sew, 159, 160, 220, 240, 450	639-804-000
5-7 mm	320, 340, 3210J, 530, 550, 560, 570a	540-401-026
5-7 mm	580+, 80	820-827-007
9 mm	680+, 710, 720PRO, 730PRO, 770, 772, 780+, 782, 790PRO/dressmaker, 792PRO, 850, 920	859-856-005
Embroidery		852-802-108
Overlock	808, 830, 830L	784-860-100
Coverstitch	264, 664, 664PRO, 864air, 845 easycover, covermax	795-802-005

# LES AIGUILLES

Chaque tissu mérite d'être travaillé avec une aiguille particulière.  
Un bon nombre de difficultés rencontrées pendant la couture peuvent être évitées  
avec une utilisation correcte des accessoires et surtout, le choix de la bonne aiguille!  
Pour assurer une qualité sans faille, toutes nos aiguilles sont fabriquées par la maison Schmetz.

## AIGUILLES UNIVERSELLES

### Dénomination et type - Application - Référence

**Système 130/705 H:** Avec pointe légèrement arrondie qui évite les points sautés et les blocages pour une couture fluide sur de nombreuses matières.

Aiguilles H 60/8	Aiguilles universelles, 5 pièces, taille 60	424-830-10
Aiguilles H 70/10	Aiguilles universelles, 5 pièces, taille 70	424-840-10
Aiguilles H 80/12	Aiguilles universelles, 5 pièces, taille 80	424-850-10
Aiguilles H 90/14	Aiguilles universelles, 5 pièces, taille 90	424-860-10
Aiguilles H 100/16	Aiguilles universelles, 5 pièces, taille 100	424-870-10
Aiguilles H 110/18	Aiguilles universelles, 5 pièces, taille 110	424-880-10
Aiguilles H 120/19	Aiguilles universelles, 5 pièces, taille 120	424-890-10
Aiguilles H 70/80/90	Set d'aiguilles universelles: 2x70 / 2x80 / 1x90	424-451-20

Aiguilles universelles jumelées et triples.

Aiguilles H-ZWI 70/1,6	2 Aiguilles jumelées 1,6 mm Universelle, taille 70	427-185-20
Aiguille H-ZWI 80/2,0	Aiguille jumelée 2 mm Universelle, 1 pce, taille 80	427-630-10
Aiguille H-ZWI 80/4,0	Aiguille jumelée 4 mm Universelle, 1 pce, taille 80	427-610-10
Aiguille H-ZWI BR 100/6,0	Aiguille jumelée 6 mm Universelle, 1 pce, taille 100	427-611-10
Aiguille H-DRI 80/2,5	Aiguille triple 2,5 mm Universelle, 1 pce, taille 80	427-045-20
Aiguille H-DRI 80/3,0	Aiguille triple 3 mm Universelle, 1 pce, taille 80	427-046-20
Aiguilles H-ZWI 80/2,0-2,5-4	Set d'aiguilles jumelées: 1x80/2 1x80/2,5 1x80/4	427-680-20

## CUIR

**Système 130/705 H LL:** Avec pointe tranchante pour faciliter la perforation. Pour le cuir, le similicuir ou les matières similaires.

Aiguilles H-LL 80/12	Aiguilles pour le cuir, 5 pièces, taille 80	424-495-20
Aiguilles H-LL 90/14	Aiguilles pour le cuir, 5 pièces, taille 90	424-490-20
Aiguilles H-LL 100/16	Aiguilles pour le cuir, 5 pièces, taille 100	424-491-20
Aiguilles H-LL 110/18	Aiguilles pour le cuir, 5 pièces, taille 110	424-492-20

## SURJETEUSES / RECOUVREUSES

**Système ELx705:** Pointe renforcée et chas plus long pour permettre les points chaînettes des surjeteuses et recouvreuses.

Aiguilles ELx705 80/12	Aiguilles pour surjeteuse, 5 pièces, taille 80	396-013-92
Aiguilles ELx705 90/14	Aiguilles pour surjeteuse, 5 pièces, taille 90	396-013-93
Aiguilles ELx705 80/90	Set d'aiguilles pour surjeteuse: 2x80 / 3x90	396-002-27

## JEANS ET DENIM

**Système 130/705 H-J:** La pointe à bille moyenne pique plus facilement les tissus épais et serrés sans les léser. La tige renforcée dévie moins et réduit le risque de points sautés ou d'aiguille cassée.

Aiguilles H-J 70/10	Aiguilles pour le Jeans, 5 pièces, taille 70	424-265-20
Aiguilles H-J 90/14	Aiguilles pour le Jeans, 5 pièces, taille 90	424-260-20
Aiguilles H-J 100/16	Aiguilles pour le Jeans, 5 pièces, taille 100	424-261-20
Aiguille H-J ZWI 100/4,0	Aiguille jumelée 4mm pour Jeans, 1 pce taille 100	427-615-20

## **STRETCH**

### Dénomination et type - Application - Référence

Système 130/705 H-S: Avec pointe à bille moyenne. Sa forme évite les points sautés dans les matières élastiques, les tricots et la maille.

Aiguilles H-S 75/11	Aiguilles pour tissus stretch, 5 pièces, taille 75	424-245-20
Aiguilles H-S 90/14	Aiguilles pour tissus stretch, 5 pièces, taille 90	424-240-20
Aiguille H-S ZWI 75/2,5	1 aiguille jumelée 2,5 mm pour stretch, taille 75	427-176-20
Aiguille H-S ZWI 75/2,5	2 aiguilles jumelées 2,5 mm pour Stretch, taille 75	427-175-20
Aiguilles H-S ZWI 75/4,0	2 aiguilles jumelées 4 mm pour Stretch, taille 75	424-246-20

## **JERSEY / TRICOT**

Système 130/705 H SUK: Avec pointe à bille moyenne. Idéales pour les tricots et la maille.

Aiguilles H-SUK 70/10	Aiguilles pour la maille, 5 pièces, taille 70	424-845-10
Aiguilles H-SUK 90/14	Aiguilles pour la maille, 5 pièces, taille 90	424-865-10
Aiguilles H-SUK 70/80/90	Set d'aiguilles pour la maille: 2x70 / 2x80 / 1x90	427-155-20

## **MICROTEX**

Système 130/705 H-M: Avec pointe fine et pointue pour perforer les tissus très fins ou très denses. Convient pour soie, microfibre, matières enduites et similicuir.

Aiguilles H-M 70/10	Aiguilles Microtex, 5 pièces, taille 70	424-841-10
Aiguilles H-M 80/12	Aiguilles Microtex, 5 pièces, taille 80	424-851-10
Aiguilles H-M 60/70/80	Set d'aiguilles Microtex: 2x60 / 2x70 / 1x80	424-452-20

## **OURLET À JOUR**

Système 130/705 H WING: Contient une tige avec une ailette sur le côté pour repousser le tissu et former un espace. Pour coutures fantaisies et ajourés dans des tissages légers.

Aiguille WING 100/16	Aiguille à ailette, 1 pièce, taille 100	427-240-20
Aiguille WING 120/19	Aiguille à ailette, 1 pièce, taille 120	427-245-20
Aiguilles ZWIHO 100	Aiguille jumelée 3 mm, 1 pièce, taille 100	427-042-20
Aiguilles ZWIHO	Aiguilles jumelées 3 mm, 2 pièces, taille 100	427-041-20
Aiguilles ZWIHO	Aiguilles jumelées 3 mm, 3 pièces, taille 100	427-040-20

## **QUILTING**

Système 130/705 H-Q: Avec pointe arrondie et fine pour perforer les couches épaisses de tissu sans léser la matière.

Aiguilles H-Q 75/90	Set d'aiguilles pour quilting: 3x75 / 2x90	424-455-20
---------------------	--	------------

## **BRODERIE**

Système 130/705 H-E: Avec une petite pointe à bille et un chas plus large pour les fils plus gros et les fils de broderie.

Aiguilles H-E 75/90	Set d'aiguilles à broder: 3x75 / 2x90	424-456-20
---------------------	---------------------------------------	------------

## **FIL MÉTALLIQUE**

Système 130 MET: Avec un chas plus long pour les fils décoratifs ou les fils spéciaux. Idéale pour les fils métalliques.

Aiguilles H-M 90/14	Aiguille pour fil métallique, 5 pièces, taille 90	424-861-10
---------------------	---	------------





*crafted with love*

Elna International Corp. SA, Genève, Suisse

Sous réserve de modification sans préavis

© 2023

[elna.com](http://elna.com)